

Instruction Manual

HI 9813 HI 9813-5 & HI 9813-6 Portable pH/EC/TDS/°C Meters

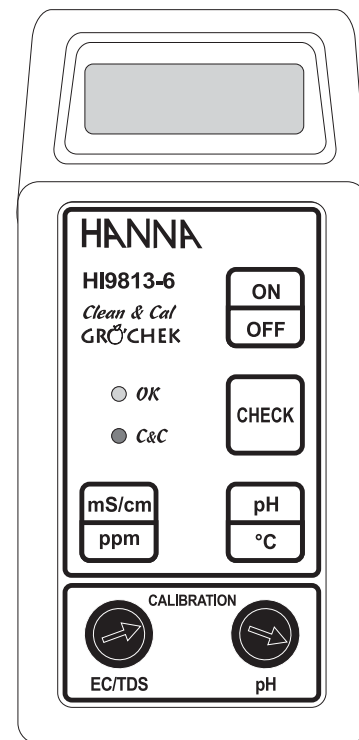

MAN9813-2
03/03

 **HANNA**
instruments

w w w . h a n n a c a n . c o m

 **HANNA**
instruments
www.hannacan.com

CE

These Instruments are in
Compliance with the CE Directives

Dear Customer,

Thank you for choosing a Hanna product.

Please read this instruction manual carefully before using the meter.

This manual will provide you with the necessary information for correct use of the instrument, as well as a precise idea of its versatility.

If you need additional technical information, do not hesitate to e-mail us at techserv@hannacan.com.

These instruments are in compliance with the CE directives.

WARRANTY

All Hanna Instruments meters are warranted for two years against defects in workmanship and materials when used for their intended purpose and maintained according to instructions. Probes are warranted for a period of six months.

This warranty is limited to repair or replacement free of charge.

Damages due to accidents, misuse, tampering or lack of prescribed maintenance are not covered.

If service is required, contact the dealer from whom you purchased the instrument. If under warranty, report the model number, date of purchase, serial number and the nature of the failure. If the repair is not covered by the warranty, you will be notified of the charges incurred. If the instrument is to be returned to Hanna Instruments, first obtain a Returned Goods Authorization number from the Customer Service department and then send it with shipping costs prepaid. When shipping any instrument, make sure it is properly packaged for complete protection.

TABLE OF CONTENTS

PRELIMINARY EXAMINATION	3
GENERAL DESCRIPTION	3
FUNCTIONAL DESCRIPTION, HI 9813 & HI 9813-5	4
FUNCTIONAL DESCRIPTION, HI 9813-6	5
SPECIFICATIONS	6
OPERATIONAL GUIDE	7
pH CALIBRATION	9
pH VALUES AT VARIOUS TEMPERATURES	10
EC/TDS CALIBRATION	11
PROBE MAINTENANCE	12
BATTERY REPLACEMENT	13
ACCESSORIES	14
CE DECLARATION OF CONFORMITY	15

CE DECLARATION OF CONFORMITY



DECLARATION OF CONFORMITY

We

Hanna Instruments Italia Srl
via E. Fermi, 10
35030 Sarmeola di Rubano - PD
ITALY

herewith certify that the pH/EC/TDS/temperature meters:

HI 9813, HI 9813-5 and HI 9813-6

have been tested and found to be in compliance with EMC Directive 89/336/EEC and Low Voltage Directive 73/23/EEC according to the following applicable normatives:

EN 50082-1: Electromagnetic Compatibility - Generic Immunity Standard
IEC 61000-4-2 Electrostatic Discharge
IEC 61000-4-3 RF Radiated

EN 50081-1: Electromagnetic Compatibility - Generic Emission Standard
EN 55022 Radiated, Class B

EN61010-1: Safety requirements for electrical equipment for measurement, control and laboratory use

Date of Issue: 04/10/2002

A. Marsilio - Technical Director
On behalf of
Hanna Instruments S.r.l.

Recommendations for Users

Before using these products, make sure that they are entirely suitable for the environment in which they are used. Operation of these instruments in residential areas could cause unacceptable interferences to radio and TV equipment.

The glass bulb at the end of the electrode is sensitive to electrostatic discharges. Avoid touching this glass bulb at all times. During operation, ESD wrist straps should be worn to avoid possible damage to the electrode by electrostatic discharges.

Any variation introduced by the user to the supplied equipment may degrade the instrument's EMC performance.

To avoid electrical shock, do not use these instruments when voltages at the measurement surface exceed 24VAC or 60VDC.

To avoid damages or burns, do not perform any measurement in microwave ovens.

All rights are reserved. Reproduction in whole or in part is prohibited without the written consent of the copyright owner, Hanna Instruments Inc.

ACCESSORIES

PROBES

- HI 1285-0** Combination, amplified pH/EC/TDS probe with built-in temperature sensor, 8-pin DIN connector and 1 m (3.3') cable
- HI 1285-5** Combination, amplified pH/EC/TDS/temperature probe with built-in temperature sensor, 8-pin DIN connector and 1 m (3.3') cable
- HI 1285-6** Combination, amplified pH/EC/TDS/temperature probe with Cal-Check feature, built-in temperature sensor, 8-pin DIN connector and 1 m (3.3') cable

pH BUFFER SOLUTIONS

- HI 7004L** pH 4.01 buffer solution, 500 mL bottle
- HI 7006L** pH 6.86 buffer solution, 500 mL bottle
- HI 7007L** pH 7.01 buffer solution, 500 mL bottle
- HI 7009L** pH 9.18 buffer solution, 500 mL bottle
- HI 7010L** pH 10.01 buffer solution, 500 mL bottle

CONDUCTIVITY & TDS CALIBRATION SOLUTIONS

- HI 7031L** 1413 $\mu\text{S}/\text{cm}$ solution, 460 mL bottle
- HI 7442L** 1500 ppm (mg/L) solution, 460 mL bottle

OTHER SOLUTIONS

- HI 700661P** Cleaning Solution, 20 mL sachet (25 pcs)
- HI 50021P** Check Solution, 20 mL sachet (25 pcs)
- HI 70300L** Storage Solution, 500 mL bottle
- HI 7073L** Protein Cleaning Solution, 500 mL bottle
- HI 7074L** Inorganic Cleaning Solution, 500 mL bottle
- HI 7077L** Oil & Fat Cleaning Solution, 500 mL bottle

OTHER ACCESSORIES

- CHECKTEMPC** Electronic thermometer (-50.0 to 150.0°C)
- HI 710001** Soft carrying case
- HI 710031** Rugged carrying case

Hanna Instruments reserves the right to modify the design, construction and appearance of its products without advance notice.

PRELIMINARY EXAMINATION

Remove the instrument from the packing material and examine it carefully to make sure that no damage has occurred during shipment. If noticeable damage is found, notify your dealer.

Each meter is supplied with:

- Combination probe with 8-pin DIN connector & 1 m (3.3') cable:
HI 1285-0, pH/EC/TDS probe, for **HI 9813**;
HI 1285-5, pH/EC/TDS/°C probe, for **HI 9813-5**;
HI 1285-6, pH/EC/TDS/°C probe with Cal-Check feature, for **HI 9813-6**
- **HI 70007** pH 7.01 sachet, 1 pc
- **HI 70031** 1413 $\mu\text{S}/\text{cm}$ (1.413 mS/cm) sachet, 1 pc
- **HI 70442** 1500 ppm sachet, 1 pc
- **HI 700661** Cleaning Solution sachet, 2 pcs
- **HI 50021** Check Solution sachet, 2 pcs, for **HI 9813-6** only
- Instruction Manual
- 1 x 9V alkaline battery.

Note: Save all packing material until you are sure that the instrument functions correctly. Any defective items must be returned in the original packing together with the supplied accessories.

GENERAL DESCRIPTION

HI 9813, **HI 9813-5** and **HI 9813-6** are complete, versatile and waterproof portable combined meters designed with utmost precision and simplicity. All the three models provide measurements of pH, EC and TDS ranges, which can be easily selected using a membrane keyboard on the front panel.

Conductivity measurements are automatically compensated for temperature changes with a built-in temperature sensor. The temperature coefficient is fixed at 2%/°C.

- **HI 9813** is a pH/EC/TDS meter designed for simplicity of use in taking pH, mS/cm and ppm measurements. Suited for hydroponics, greenhouses, farming and ground water applications.
- **HI 9813-5** offers all the features of **HI 9813** with the addition of temperature measurement in the °C scale.
- **HI 9813-6** is the most complete model, including the Cal-Check feature, which allows the user to easily check the probe calibration status at any time.

FUNCTIONAL DESCRIPTION HI 9813 AND HI 9813-5

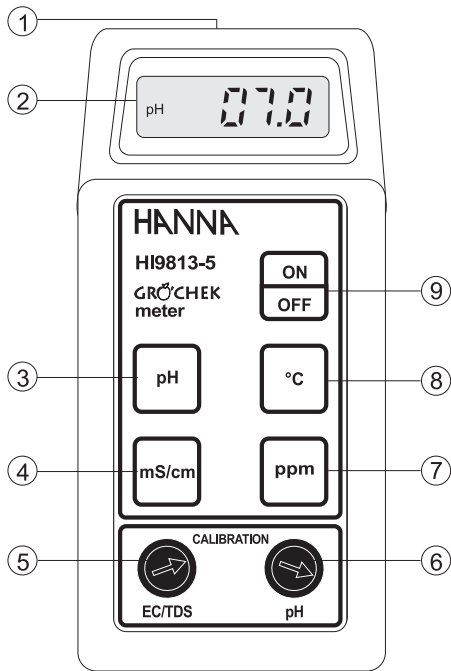

- 1) 8-pin DIN connector for probe
- 2) Liquid Crystal Display
- 3) pH range selection key
- 4) mS/cm (EC) range selection key
- 5) EC/TDS calibration knob
- 6) pH offset calibration knob
- 7) ppm (TDS) selection key
- 8) °C (Temperature) selection key, for HI 9813-5 only
- 9) ON/OFF key

4. if the red LED lights up again, calibration is needed (see "pH Calibration" section).

Note: If it is not possible to calibrate, the probe has to be replaced with a new one.

Note: For field applications, it is always recommended to keep a spare probe handy. When anomalies are not resolved with simple maintenance, change the probe and recalibrate the meter.

BATTERY REPLACEMENT

These meters are powered by a 9V battery that is located on the rear of the instrument.

When the battery level is so low that it may cause unreliable measurements, the meter turns off.

It is recommended to replace the battery immediately.

Battery replacement must only take place in a nonhazardous area using a 9V alkaline battery.

Unscrew the three screws on the rear of the meter, remove the battery compartment cover and replace the 9V battery with a new one while paying attention to its polarity.

Make sure the battery contacts are tight and secure before replacing the cover.

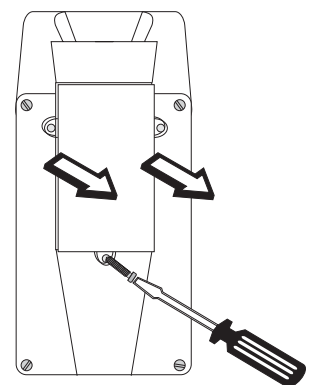

PROBE MAINTENANCE

PERIODIC MAINTENANCE

Inspect the probe and the cable. The cable used for the connection to the meter must be intact and there must be no points of broken insulation on the cable or cracks on the probe stem or bulb.

Connector must be perfectly clean and dry. If any scratches or cracks are present, replace the electrode. Rinse off any salt deposits with water.

CLEANING PROCEDURE

For better accuracy in measurements and to ensure a good performance of the probe, a frequent cleaning is recommended.

For this purpose, soak it in Hanna HI 700661 Cleaning Solution for 5 minutes.

Note: For particular dirty (as for example protein, oil or grease) see the "Accessories" section for Hanna specific solutions.

HI 9813-6 only:

CAL-CHECK FEATURE / CLEAN & CAL PROCEDURE

The unique Cal-Check feature allows the user to check the meter calibration status at any time. Simply follow the below procedure for a quick and easy operation.

- Rinse the probe with water.
- Immerse the probe in the HI 50021 Check Solution.

Note: If the reading is around pH 4.0, the probe is broken and has to be replaced.

- Press the CHECK key.
- If the green LED lights up, the meter is calibrated.
- If the red LED lights up, Cleaning is needed:

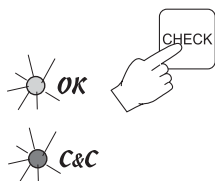

1. immerse the probe in the HI 700661 Cleaning Solution (or in one of the available specific solutions - see "Accessories" section) for 5 minutes, then rinse it with tap water;
2. immerse again in the HI 50021 Check Solution and press the CHECK key;
3. if the green LED lights up, the meter does not need calibration;

FUNCTIONAL DESCRIPTION HI 9813-6

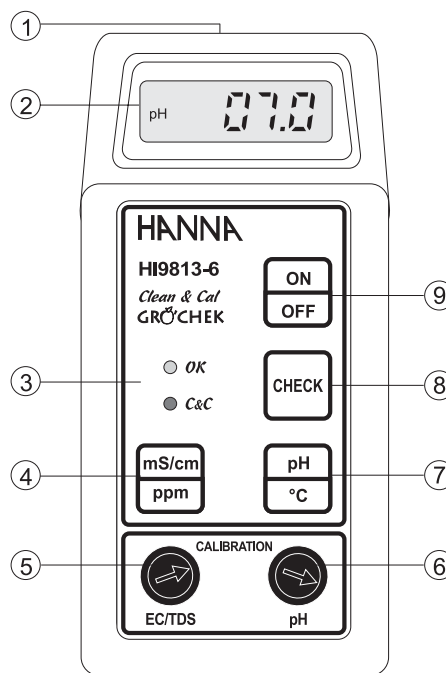

- 1) 8-pin DIN connector for probe
- 2) Liquid Crystal Display
- 3) Green and Red LEDs for Cal-Check
- 4) mS/cm / ppm (EC/TDS) range selection key
- 5) EC/TDS calibration knob
- 6) pH offset calibration knob
- 7) pH/°C range selection key
- 8) Check key
- 9) ON/OFF key

SPECIFICATIONS

Range	pH	0.0 to 14.0
	ppm	0 to 1999
	mS/cm	0.00 to 4.00
	°C	0.0 to 60.0 (HI 9813-5 & HI 9813-6)
Resolution	pH	0.1
	ppm	1
	mS/cm	0.01
	°C	0.1 (HI 9813-5 & HI 9813-6)
Accuracy (@20°C/68°F)	pH	±0.1
	ppm	±2% f.s.
	mS/cm	±2% f.s.
	°C	±0.5 (HI 9813-5 & HI 9813-6)
Conversion Factor		variable, 0.56 to 0.72
Typical EMC Deviation	pH	±0.1
	ppm	±2% f.s.
	mS/cm	±2% f.s.
	°C	±0.5 (HI 9813-5 & HI 9813-6)
pH Calibration		Manual, 1-point through offset trimmer
EC/TDS Calibration		Manual, 1-point through slope trimmer
EC/TDS Temperature Compensation		Automatic from 0 to 50°C (32 to 122°F) with $\beta = 2\%/^{\circ}\text{C}$
Probe (included)		HI 1285-0 for HI 9813 HI 1285-5 for HI 9813-5 HI 1285-6 for HI 9813-6
Battery Type		1 x 9V alkaline (IEC 6LR61)
Life		approx. 150 hours of continuous use
Environment		0 to 50°C (32 to 122°F); 100% RH
Dimensions		165 x 75 x 45 mm (6.5 x 3.0 x 1.8")
Weight		250 g (8.8 oz.)

EC/TDS CALIBRATION

Accessories needed:

- Use **HI 70031** ($1413 \mu\text{S}/\text{cm} = 1.413 \text{ mS}/\text{cm}$) EC calibration solution or **HI 70442** (1500 ppm) TDS calibration solution.

Note: The conversion between EC and TDS is made by a built-in circuit, hence it is requested to calibrate the meter only in EC or TDS range. The other range is thus automatically calibrated.

PROCEDURE

- Pour approximately 4 cm (1½") of a conductivity calibration solution (e.g. **HI 7031**) into a beaker. If possible, use plastic beaker to minimize any EMC interference.
- Immerse the probe in the solution.
- Wait for a couple of minutes for thermal equilibrium to be reached.
- Tap the probe on the bottom, then shake it lightly while rotating to make sure no air bubbles remain trapped inside the probe.
- Press the "mS/cm" (or "ppm") key.
- Turn the EC/TDS calibration knob until the display shows the EC or TDS reading at 25°C.



Note: The probe should be submerged approximately 4 cm (1½") into the solution. The **ChecktempC** thermometer has to be located close to the probe.

Note: If turning the knob the needed value can not be reached, clean the probe (see the "Probe Maintenance" section).

If also after the probe cleaning the value can not be reached, replace the probe.

pH VALUES AT VARIOUS TEMPERATURES

For temperature compensation during calibration, please refer to the following chart.

TEMP		pHVALUES				
°C	°F	4.01	6.86	7.01	9.18	10.01
0	32	4.01	6.98	7.13	9.46	10.32
5	41	4.00	6.95	7.10	9.39	10.24
10	50	4.00	6.92	7.07	9.33	10.18
15	59	4.00	6.90	7.04	9.27	10.12
20	68	4.00	6.88	7.03	9.22	10.06
25	77	4.01	6.86	7.01	9.18	10.01
30	86	4.02	6.85	7.00	9.14	9.96
35	95	4.03	6.84	6.99	9.10	9.92
40	104	4.04	6.84	6.98	9.07	9.88
45	113	4.05	6.83	6.98	9.04	9.85
50	122	4.06	6.83	6.98	9.01	9.82
55	131	4.07	6.84	6.98	8.99	9.79
60	140	4.09	6.84	6.98	8.97	9.77
65	149	4.11	6.85	6.99	8.95	9.76
70	158	4.12	6.85	6.99	8.93	9.75

For instance, if the buffer temperature is 25°C, the display should show pH 4.0 or 7.0 or 10.0.

If the buffer temperature is 10°C, the display should show pH 4.0 or 7.0 or 10.1.

OPERATIONAL GUIDE

INITIAL PREPARATION

Each meter is supplied complete with a 9V battery. Remove the battery compartment cover on the back of the meter and install the battery while paying attention to its polarity.

Connect the probe to the DIN socket on the top of the meter by aligning the pins with the socket and pushing in the plug.

Always remove the probe protective cap before taking any measurements, and make sure the meter has been calibrated.

Turn the meter on by pressing the ON/OFF key.



TAKING pH MEASUREMENTS

If the probe has been left dry, soak the tip in **HI 70300** storage solution for a few minutes to reactivate it.

- To take a pH measurement simply submerge the tip (4cm/1½") of the probe into the sample to be tested.



- Select the pH mode.



- Stir briefly and wait a couple of minutes for the reading to adjust and stabilize. The display shows the pH value.



- If measurements are taken in different samples successively, it is recommended to rinse (clean) the probe thoroughly to eliminate cross-contamination. After cleaning, it is recommended to rinse the probe with some of the next sample to be measured.

TAKING EC/TDS MEASUREMENTS

- Immerse the tip of the probe (4cm/1½") into the sample to be tested. If possible, use plastic beakers or containers to minimize any EMC interference.



- Tap the probe lightly on the bottom of the beaker to remove any air bubbles which may be trapped inside the tip.

- Select the appropriate measurement range (EC or TDS).



- Wait for a couple of minutes for the temperature sensor to reach thermal equilibrium. The display then shows the measurement automatically compensated for temperature with the appropriate following indication: "mS" tag indicates the meter is in EC mode, while no symbol indicates the meter is in TDS mode.



TAKING TEMPERATURE MEASUREMENTS (not for HI 9813)

- Submerge the tip (4cm/1½") of the probe into the sample to be tested.

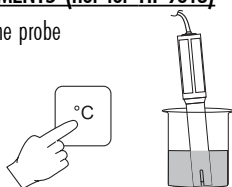

- Select the °C mode.
- Stir briefly and wait a couple of minutes for the reading to adjust and stabilize. The display shows the temperature value.



Note: If the display shows only a "1" on the far left hand side, the reading is out of range.



Note: It is recommended to clean often the probe with HI 700661 Cleaning Solution.

Note: After measurements have been completed, the instrument should be switched off, and the probe cleaned and covered with the protective cap.

pH CALIBRATION

For greatest accuracy, frequent calibration of the instrument is recommended. The instrument should be recalibrated for pH:

- Whenever the electrode is replaced.
- At least once a month.
- After testing aggressive chemicals.
- Where extreme accuracy is required.
- Whenever the CAL-CHECK test fails (HI 9813-6 only).

PREPARATION

Pour small quantities of pH 7.01 (HI 7007) or pH 4.01 (HI 7004) or pH 10.01 (HI 7010) solution into a clean beaker.

To obtain accurate readings, use pH 7.01 (HI 7007) if you are going to measure neutral or close to neutral samples, pH 4.01 (HI 7004) if you are going to measure acidic samples or pH 10.01 (HI 7010) for alkaline measurements.

If you need to calibrate to NBS standards, use pH 6.86 (HI 7006) instead of pH 7.01 and pH 9.18 (HI 7009) instead of pH 10.01.

PROCEDURE

- Connect the probe and switch the meter on, then press the "pH" key to display pH measurement.
- Remove the protective cap from the probe, rinse and immerse it in the buffer and stir gently. Wait a couple of minutes for the reading to stabilize.

- Take the temperature of the buffer solution, e.g. 10.0°C, as follow:

for HI 9813, with a ChecktempC (or another accurate thermometer);

for HI 9813-5 and HI 9813-6, select the °C mode and read the displayed value.

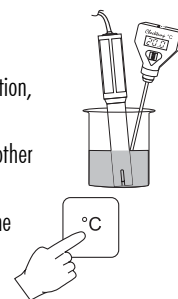

- Adjust the pH calibration knob until the LCD shows the pH value at the above temperature (see the pH versus temperature chart).



- The pH calibration is now complete.