

pHep[®]
HI 98107
Pocket-sized pH Meter

pHep is a rugged pH tester with replaceable electrode and renewable reference junction. The instrument can be calibrated at two points by the user, simply acting on the offset and slope calibration trimmers.

CONDITIONING:

- Remove the cap.
- To activate the electrode, immerse it in HI70300 storage solution for 2 hours.



CALIBRATION:

Perform one of the following two-point calibration procedure, according to the required application:

Acid calibration for measurements below pH 7:

- Immerse the electrode in pH 7.01 (HI7007) buffer solution.
- Allow the reading to stabilize and with a small screwdriver turn the pH7 Calibration Trimmer until the display shows "7.0".
- Rinse the electrode with tap water and immerse it in pH 4.01 (HI7004) buffer solution.
- Allow the reading to stabilize and with a small screwdriver turn the pH4/pH10 Calibration Trimmer until the display shows "4.0".



Alkaline calibration for measurements above pH 7:

- Immerse the electrode in pH 7.01 (HI7007) buffer solution.
- Allow the reading to stabilize and with a small screwdriver turn the pH7 Calibration Trimmer until the display shows "7.0".
- Rinse the electrode with tap water and immerse it in pH 10.01 (HI7010) buffer solution.
- Allow the reading to stabilize and with a small screwdriver turn the pH4/pH10 Calibration Trimmer until the display shows "10.0".

OPERATION:

- Remove the protective cap.
- Turn the meter on with the ON/OFF switch located on the top of the meter.
- Immerse it in the solution to be tested without exceeding the maximum immersion level.



- Stir gently and wait for the reading to stabilize.
- After use, rinse the electrode with tap water to minimize contamination.
- Store the electrode with a few drops of storage (HI70300) or pH7 (HI7007) solution in the protective cap.



- Always replace the protective cap after use.

DO NOT USE DISTILLED OR DEIONIZED WATER FOR STORAGE PURPOSES.

- Large differences in pH readings (± 1 pH) could be due to lack of calibration or dry electrode.

MAINTENANCE:

The sensor should be kept moist at all times. For this purpose, always keep wet the tissue inside the protective cap. In case of erroneous readings even after an accurate conditioning and calibration, the reference junction might be contaminated or clogged.

Pull out 2 mm (1/8") of the cloth junction to renew the electrode reference (it is recommended to cut the cloth leaving always at least 2 mm - 1/8" over the reference compartment) and repeat the calibration procedure.

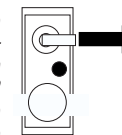

The cloth junction can be pulled out approximately 20 times. After that, the electrode can be replaced (see the Electrode Replacement section).

BATTERY REPLACEMENT:

If calibration can not be performed or the display fades, batteries level is low and batteries must be replaced. Slide off the battery compartment cover and replace all four 1.5V batteries while paying attention to their polarity.

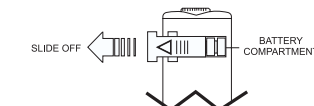

Batteries should only be replaced in a nonhazardous area using the battery type specified in this instruction manual.



pHep®

HI 98107

Pocket-sized pH Meter

SPECIFICATIONS:

RANGE	0.0 to 14.0 pH
RESOLUTION	0.1 pH
ACCURACY (@20°C/68°F)	±0.1 pH
TYPICAL EMC DEVIATION	±0.1 pH
ENVIRONMENT	0 to 50°C (32 to 122°F); 95% RH
CALIBRATION	Manual, at two points through offset and slope trimmers
BATTERY TYPE	4 x 1.5V alkaline (included)
BATTERY LIFE	approx. 1700 hours of continuous use
DIMENSIONS	175 x 41 x 23 mm (7.9 x 1.8 x 1")
WEIGHT	78 g (2.7 oz.)

ACCESSORIES:

HI 73106	Spare electrode
HI 77400P	pH 4.01 & 7.01 calibration kit (5 x 20 mL, each)
HI 77700P	pH 7.01 calibration kit (10 x 20 mL)
HI 770710P	pH 7.01 & 10.01 calibration kit (5 x 20 mL, each)
HI 7004M	pH 4.01 buffer solution (230 mL bottle)
HI 7007M	pH 7.01 buffer solution (230 mL bottle)
HI 7010M	pH 10.01 buffer solution (230 mL bottle)
HI 70300M	Storage solution (230mL)
HI 7061M	Electrode cleaning solution (230mL bottle)
HI 731326	Calibration screwdriver (20 pcs)

Visit our Internet Home Page:
<http://www.hannainst.com>

HANNA
instruments

ISS98107-F3 09/01

ELECTRODE REPLACEMENT:

The electrode can be easily replaced in the following way:

- Slide off the battery cover.
- Remove the screw on the back of the pHep located below the battery compartment and slide off the whole internal part of the tester.

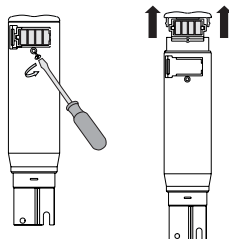

Internal circuit and electrode:

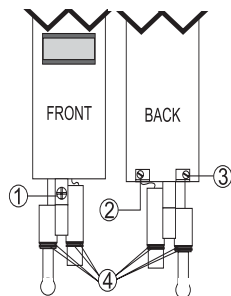

- Reinsert the battery compartment cover.

- To remove the electrode proceed as follows:
Remove the fastening screw on the front (1) to loose the electrode. The internal circuit is connected to the electrode through two wires (one for the glass sensor and one for the reference). Remove the two small screws (2 & 3) which fasten the two connecting wires to their sockets.

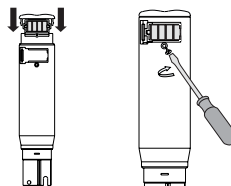

- Remove the electrode and replace it with a new HI73106.

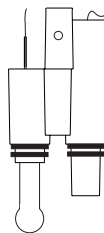

- Connect the new electrode as follows:
first fasten the screw on the front (1) to attach the electrode to the circuit. Insert the two small wires into their sockets and fasten the two screws (2 & 3).

- The new electrode is supplied with four new O-rings (4). Make sure they are placed properly (as shown on the above drawing) before reinserting the circuit into the plastic casing.
- Reinsert the internal circuit with the new electrode into the plastic casing.
- Fasten the screw on the back below the battery compartment.

ONE YEAR WARRANTY & SERVICEABLE:

Covered by **one year** warranty against defects in workmanship and materials, this tester is now completely serviceable. Contact your dealer for further information.

The pHep is in compliance with the CE directives EN 50082-1, EN 50081-1 and EN 61010-1.

pHep® is a registered Trademark of "Hanna Instruments"