

## Instruction Manual

---

**HI 931100**

**HI 931101**

**HI 931102**

**Foodcare**

**Water-resistant  
Microprocessor-based  
Sodium / Sodium Chloride  
Meters**



---

This Instrument is in Compliance with the CE Directives

 **HANNA**  
instruments  
[www.hannacan.com](http://www.hannacan.com)



Dear Customer,  
Thank you for choosing a Hanna Instruments Product.  
Please read this instruction manual carefully before using the instrument.  
This manual will provide you with all the necessary information for the correct use of the instrument, as well as a precise idea of its versatility in a wide range of applications.  
These instruments are in compliance with **CE** directives EN 50081-1 and EN 50082-1.

## TABLE OF CONTENTS

Preliminary Examination .....	1
General Description .....	1
Functional Description HI931100 .....	2
Specifications HI931100 .....	3
Functional Description HI931101 .....	4
Specifications HI 931101 .....	5
Functional Description HI931102 .....	6
Specifications HI931102 .....	7
Operational Guide .....	8
Na Calibration (HI931101) .....	12
NaCl Calibration (HI931100/HI931102) .....	16
Special Applications & Add'l Information ..	20
Temperature Calibration .....	23
FC300B Conditioning & Maintenance .....	26
Battery Replacement .....	31
Accessories .....	32
Warranty .....	36
CE Declaration of Conformity .....	37

## PRELIMINARY EXAMINATION

Remove the instrument from the packing material and examine it carefully to make sure that no damage has occurred during shipping. If there is any noticeable damage, notify your Dealer.

Each meter is supplied complete with 4 x 1.5V AA size batteries and rugged carrying case.

**Note:** Save all packing materials until you are sure that the instrument functions correctly. All defective items must be returned in the original packing materials together with the supplied accessories.

## GENERAL DESCRIPTION

Hanna Instruments microprocessor-based **Sodium (HI931101) / Sodium Chloride (HI931100/HI931102)** analysers, are housed in rugged, lightweight material designed for single-handed use.

To assure trouble-free operations, the meters' circuitry has a built-in protection against electromagnetic interference.

All meters come equipped with a large and easy-to-read LCD, which shows sodium/sodium chloride and temperature values simultaneously and guides the user through the calibration procedure with easy-to-follow graphic symbols.

In addition, **HI931101** and **HI931102** provide pNa or % NaCl readings respectively through the MODE key.

Automatic calibration, rundown batteries indicator and water-resistant housing are the features which make these meters easy to use and versatile both in the laboratory and in the field applications.

## FUNCTIONAL DESCRIPTION HI 931100

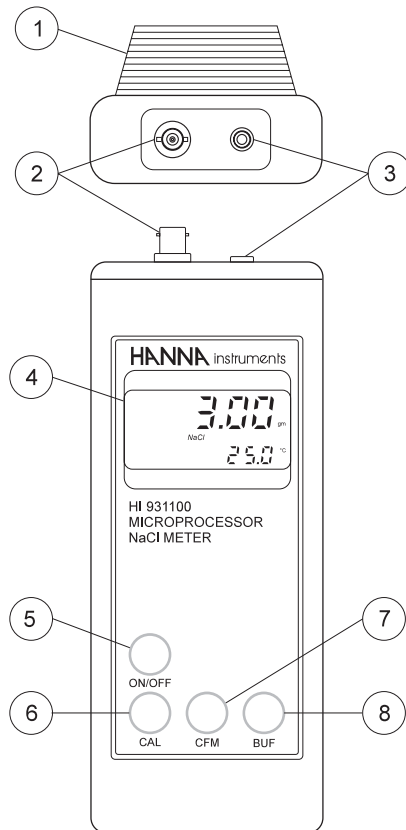

1. Battery Cover
2. BNC Electrode socket
3. RCA Temperature Probe socket
4. LCD Display
5. **ON/OFF** key, to turn the instrument on or off
6. **CAL** key, to enter or exit calibration mode
7. **CFM** key, to confirm calibration
8. **BUF** key, to select the calibration buffer value

## SPECIFICATIONS HI 931100

<b>HI 931100</b>	
<b>Measurement</b> NaCl  °C	0.150 to 1.500 g/L 1.50 to 15.00 g/L 15.0 to 150.0 g/L 150 to 300 g/L 0.0 to 80.0°C
<b>Resolution</b> NaCl  °C	0.001 g/L 0.01 g/L 0.1 g/L 1 g/L 0.1°C
<b>Accuracy</b> NaCl (@20°C/68°F) °C	±5% of reading ±0.5°C
<b>Typical</b> NaCl <b>EMC Deviation</b> °C	±2% F.S. ±0.5°C
<b>Calibration</b>	<b>Automatic 1 or 2 point</b> at 3.00 g/L ( <b>HI 7083</b> ) and 0.30 g/L ( <b>HI 7085</b> ) or 30.0 g/L ( <b>HI 7081</b> )
<b>Temperature Compensation</b>	fixed at 25°C (77°F)
<b>Electrode</b>	<b>FC 300B</b> glass combination sodium-sensitive electrode (not included)
<b>Temperature Probe</b>	<b>HI 7662</b> temperature probe (not included)
<b>Battery</b> Type Life	4 x 1.5V AA size 200 hours of continuous use
<b>Environment</b>	0 to 50°C (32 to 122°F); 100% RH
<b>Dimensions</b>	196 x 80 x 60 mm (7.7 x 3.1 x 2.4")
<b>Weight</b>	450 g (15.8 lb.)

## FUNCTIONAL DESCRIPTION HI 931101

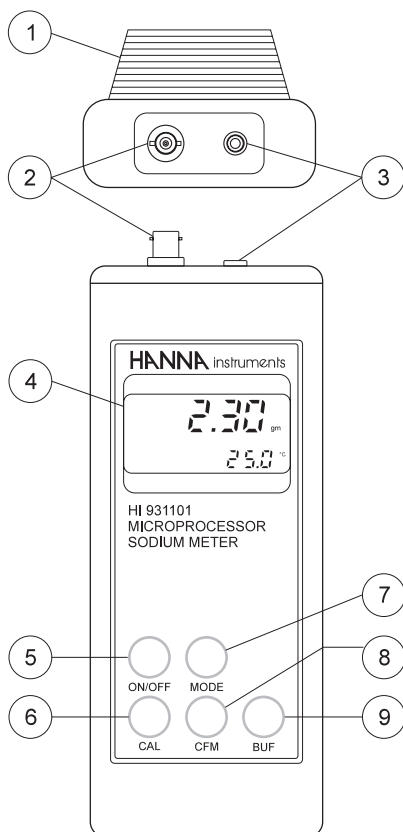

1. Battery Cover
2. BNC Electrode connector
3. RCA Temperature Probe socket
4. LCD Display
5. **ON/OFF** key to turn the instrument on or off
6. **CAL** key to enter or exit calibration mode
7. **MODE** key, to select the scale (Na or pNa)
8. **CFM** key, to confirm calibration
9. **BUF** key, to select the calibration buffer value

## SPECIFICATIONS HI 931101

		HI 931101
<b>Measurement</b>		
<b>pNa</b>		0.00 to 3.00
<b>Na</b>		15.0 to 150.0 mg/L (ppm)
		0.150 to 1.500 g/L
		1.50 to 15.00 g/L
		15.0 to 60.0 g/L
<b>°C</b>		0.0 to 80.0°C
<b>Resolution</b>		
<b>pNa</b>		0.01
<b>Na</b>		0.001 g/L
		0.01 g/L
		0.1 g/L
		1 g/L
<b>°C</b>		0.1°C
<b>Accuracy</b>		
<b>pNa</b>		±0.05
<b>(@ 20°C/68°F)</b>	<b>Na</b>	±5% of reading
	<b>°C</b>	±0.5°C
<b>Typical EMC</b>	<b>pNa</b>	±2% F.S.
<b>Deviation</b>	<b>Na</b>	±2% F.S.
	<b>°C</b>	±0.5°C
<b>Calibration</b>		<b>Automatic 1 or 2 point</b> at 2.3 g/L ( <b>HI 7080/HI 8080</b> ) and 0.23 g/L ( <b>HI 7087/HI 8087</b> ) or 23.0 g/L ( <b>HI 7086/HI 8086</b> )
<b>Temperature Compensation</b>		fixed at 25°C (77°F)
<b>Electrode</b>		<b>FC 300B</b> glass combination sodium-sensitive electrode (not included)
<b>Temperature Probe</b>		<b>HI 7662</b> temperature probe (not included)
<b>Battery</b>	<b>Type</b>	4 x 1.5V AA size
	<b>Life</b>	200 hours of continuous use
<b>Environment</b>		0 to 50°C (32 to 122°F); 100% RH
<b>Dimensions</b>		196 x 80 x 60 mm (7.7 x 3.1 x 2.4")
<b>Weight</b>		450 g (15.8 lb.)

## FUNCTIONAL DESCRIPTION HI 931102



1. Battery Cover
2. BNC Electrode connector
3. RCA Temperature Probe socket
4. LCD Display
5. **ON/OFF** key, to turn the instrument on or off
6. **CAL** key, to enter or exit calibration mode
7. **MODE** key, to select the NaCl scale (g/L or %)
8. **CFM** key, to confirm calibration
9. **BUF** key, to select the calibration buffer value



## SPECIFICATIONS HI 931102

		<b>HI 931102</b>
<b>Measurement</b>	<b>NaCl</b>	0.150 to 1.500 g/L 1.50 to 15.00 g/L 15.0 to 150.0 g/L
	<b>NaCl % °C</b>	150 to 300 g/L 0.00 to 30.00 0.0 to 80.0
<b>Resolution</b>	<b>NaCl</b>	0.001 g/L 0.01 g/L 0.1 g/L
	<b>NaCl % °C</b>	1 g/L 0.01 0.1
<b>Accuracy (@20°C/68°F) °C</b>	<b>NaCl</b>	±5% of reading
	<b>NaCl % °C</b>	±5% of reading ±0.5
<b>Typical EMC Deviation</b>	<b>NaCl</b>	±2% F.S.
	<b>NaCl % °C</b>	±2% F.S. ±0.5
<b>Calibration</b>		<b>Automatic 1 or 2 point</b> at 3.00 g/L ( <b>HI 7083</b> ) <b>and</b> 0.30 g/L ( <b>HI 7085</b> ) <b>or</b> 30.0 g/L ( <b>HI 7081</b> )
<b>Temperature Compensation</b>		fixed at 25°C (77°F)
<b>Electrode</b>		<b>FC 300B</b> glass combination sodium-sensitive electrode (not included)
<b>Temperature Probe</b>		<b>HI 7662</b> temperature probe (not included)
<b>Battery</b>	<b>Type Life</b>	4 x 1.5V AA size 200 hours of continuous use
<b>Environment</b>		0 to 50°C (32 to 122°F); 100% RH
<b>Dimensions</b>		196 x 80 x 60 mm (7.7 x 3.1 x 2.4")
<b>Weight</b>		450 g (15.8 lb.)

## OPERATIONAL GUIDE

### INITIAL PREPARATION

Each meter is supplied complete with 4 x 1.5V AA batteries.

Remove the back cover, unwrap the batteries and install them while paying attention to their polarity.

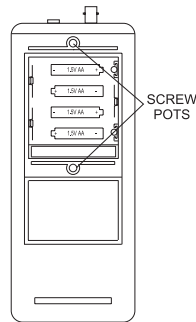

### PROBES CONNECTION

Connect the sodium-sensitive electrode **FC 300B** to the BNC socket on the top of the instrument.

Connect the optional temperature probe **HI 7662** to the RCA socket.

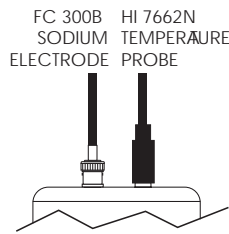

The temperature probe can be used independently to take temperature measurements.

If the probe is not plugged in, the secondary display reads 25°C and the "°C" indicator blinks.



To switch the instrument on, press and hold the ON/OFF key for a fraction of a second.



These meters have a built-in protection against electromagnetic interferences and the holding of the keys is to en-



sure that the commands are not mistaken for erroneous signals.

**In order to take accurate measurements, make sure the instrument is calibrated before use (see page 12 for HI931101 and page 16 for HI931100 & HI931102).**

For greatest accuracy, calibration should be performed (or at least verified) every day for measurements taken in the same type of samples (e.g. cheese) or every time the sample type is changed (e.g. cheese, meat, sea water, etc.).

The best working temperature is around 20-25°C (68-77°F). For greater accuracy, perform the calibration of the meter with standard solution at a temperature as close as possible to the temperature of the sample ( $\pm 1^\circ\text{C}/\pm 2^\circ\text{F}$ ).

### **TAKING SODIUM MEASUREMENTS**

Remove the protective cap of the **FC 300B** sodium-sensitive electrode and, if possible, rinse it with some of the sample you are going to measure.

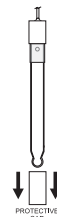

Lower the rubber sleeve to get the junction to work properly.

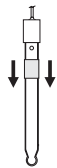

Immerse the tip of the **FC 300B** electrode (2.5 cm/ 1" i.e. the electrode junction must be completely immersed) into the sample to be tested without touching the bottom of the beaker.

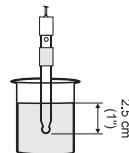

Wait for up to 10 to 15 minutes to allow for the electrode to adjust and stabilize, i.e. until there is no drifting for at least a couple of minutes.

During measurement, if possible, the sample should be gently stirred (100 rpm).

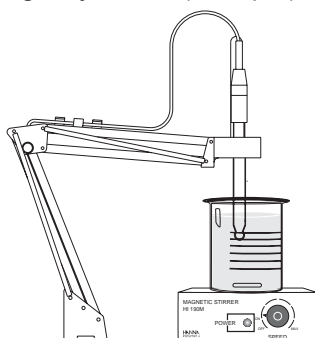

***pNa (for HI931101) and NaCl% (for HI931102) measurements***

Press the MODE key during measurement to convert the displayed value of **HI931101** to pNa.

$$pNa = -\log a_{Na}$$

where  $a_{Na}$  is the activity of ion Na.

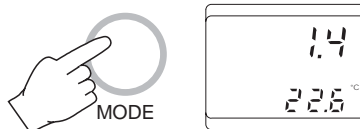

Press the MODE key during measurement to convert the displayed value of **HI931102** to %.

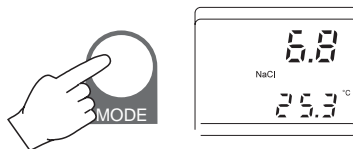

Press the same key to return to g/L measurements.

## TAKING TEMPERATURE MEASUREMENTS

To take temperature measurements, connect the temperature probe, turn the instrument on and dip the liquid/general purpose temperature probe **HI 7662** into the sample. Allow the reading to stabilize.



**Note:** the temperature is always displayed on the secondary display.



## AFTER USE

Turn the meter off by pressing the ON/OFF key again.



For a faster and accurate measure, the electrode should be stored in a solution with a Na/NaCl concentration similar to the sample to be measured.



Upper the rubber sleeve after use.

For infrequent use (once a month or less) store the electrode dry. Before using it again, let it condition overnight in **HI7081/HI8081** (30.0 g/L NaCl) or **HI7086/HI8086** (23 g/L Na 1M)

**To avoid very long response time, do not store or rinse the electrode with deionized water. Never rub or blot the electrode.**

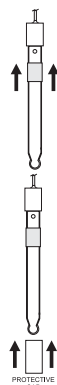

## Na CALIBRATION (HI931101)

The calibration is performed by immersing the **FC 300B** sodium-sensitive electrode in 2 different standard Na solutions to achieve accurate 2 point calibration.

It is also possible to calibrate just the offset (2.3 g/L Na) following the single point calibration procedure described below.

For best accuracy, a two-point calibration is recommended (see below).

### PREPARATION

- Pour small quantities of **HI7080** or **HI8080** (2.3 g/L Na) solution and **HI7087** or **HI8087** (0.23 g/L Na) or **HI7086** or **HI8086** (23 g/L Na) into two clean beakers.

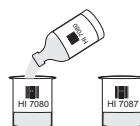

To obtain accurate readings, use HI7080/HI8080 and HI7087/HI8087 if you are going to measure samples with low sodium content (below 2.3 g/L) or HI7080/HI8080 and HI7086/HI8086 if you are going to measure samples with high sodium content (over 2.3 g/L).

- For accurate calibration use two beakers for each buffer calibration, the first

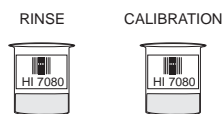

one for rinsing the electrode, the second one for calibration. This way, contamination of the buffer is minimized. Whenever possible use plastic beakers to minimize any EMC interferences.

- Turn the meter on by pressing the ON/OFF key.



- Remove the protective cap of the electrode and rinse it with some of the buffer calibration solution you are going to use first.

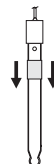

- Lower the rubber sleeve to get the junction to work properly

### SINGLE POINT CALIBRATION (OFFSET)

- Dip the **FC 300B** sodium electrode into the 2.3 g/L Na solution (**HI 7080** or **HI 8080**).

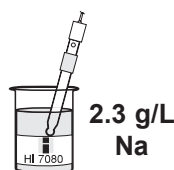

**Note:** the electrode should be immersed approximately 2.5 cm (1") into the solution.

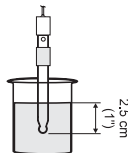

- Press the CAL key. The "CAL" and "BUF" indicators will be displayed with the "BUF" and the "⎵" symbols blinking.

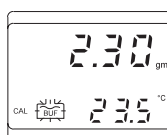

- As soon as the standard solution is recognized, the BUF symbol stays still while the "⎵" symbol continues to blink indicating that the electrode is stabilizing. The value of the standard solution being used will be displayed on the primary LCD.

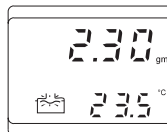
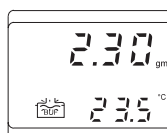

- As soon as the electrode is stabilized, "CON" symbol will appear on the display.



For best results, wait for a couple of minutes before pressing the CFM key.



- **HI931101** will display "0.230 gm".

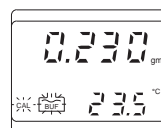

- If the CAL key is pressed at this point, the calibration process is ended providing only one point calibration. For better accuracy however, it is recommended that a two-point calibration is performed.



### **TWO POINT CALIBRATION**

- Proceed as described in "Single Point Calibration" but do not quit calibration by pressing the CAL key.

- After the first point is confirmed, immerse the **FC 300B** electrode into the second buffer solution at 0.23 g/L Na (**HI7087/ HI8087**) or 23 g/L Na (**HI7086/ HI8086**).



**0.23 g/L or 23 g/L Na**

**Note:** the electrode should be immersed approximately 2.5 cm (1") into the solution.

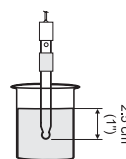

- Select the buffer value by pressing the BUF key. Make sure that the buffer value selected through the BUF key corresponds to the one being used for the second point calibration.

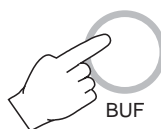



- If the reading is not close to the selected buffer, the "BUF" prompt will continue to blink.

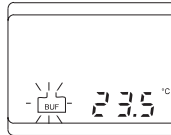

If on the other hand, the reading is close to the selected buffer, the meter will recognize the standard solution. The BUF symbol will stay still on the display, while the "⌋" symbol will blink, indicating that the meter is stabilizing its reading.

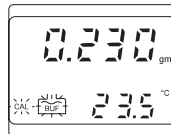

- Once stabilized "CON" symbol will appear on the display.



Wait for a couple of minutes and press the CFM key.



- The meter will return to its normal mode and the two point calibration process is completed.

## NaCl CALIBRATION (HI931100/HI931102)

The calibration is performed by immersing the **FC 300B** sodium-sensitive electrode in 2 different standard NaCl solutions to achieve accurate 2 point calibration.

It is also possible to calibrate just the offset (3.00 g/L NaCl) following the single point calibration procedure described below.

For best accuracy, a two-point calibration is recommended (see below).

### PREPARATION

- **For HI931100 and HI931102:**

Pour small quantities of **HI 7083** or **HI 8083** (3.00 g/L NaCl) solution and **HI 7085** or **HI 8085** (0.30 g/L) or **HI 7081** or **HI 8081** (30 g/L) into two clean beakers.

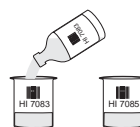

To get accurate readings use HI 7083/HI 8083 and HI 7085/HI 8085 if you are going to measure samples with low sodium chloride content (below 3 g/L) or HI 7083/HI 8083 and HI 7081/HI 8081 if you are going to measure samples with high sodium chloride content (over 3 g/L).

- For accurate calibration, use two beakers for each buffer calibration, the first

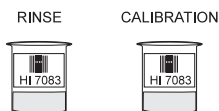

one for rinsing the electrode, the second one for calibration. This way, contamination of the buffer is minimized. Whenever possible use plastic beakers to minimize any EMC interferences.



- Turn the meter on by pressing the ON/OFF key.

- Remove the protective cap of the electrode and rinse



it with some of the buffer calibration solution you are going to use first.

- Lower the rubber sleeve to get the junction to work properly

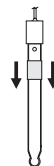

### SINGLE POINT CALIBRATION (OFFSET)

- Dip the **FC300B** sodium electrode into the 3.00 g/L NaCl solution (**HI7083** or **HI8083**).

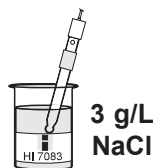

**Note:** the electrode should be immersed approximately 2.5 cm (1") into the solution.

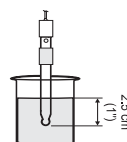

- Press the CAL key. The "CAL" and "BUF" indicators will be displayed with the "BUF" and the "⋯" symbols blinking.



- As soon as the standard solution is recognized, the BUF symbol will stay still while the "⋯" symbol will continue to blink indicating that the electrode is stabilizing.

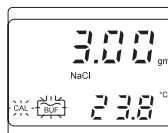

The value of the standard solution being used will be displayed on the primary LCD.



- As soon as the electrode is stabilized, "CON" symbol will appear on the display.



For best results, wait for a couple of minutes before

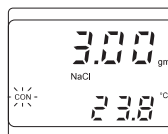

pressing the CFM key. **HI931100** and **HI931102** will then display "30.0 gm".

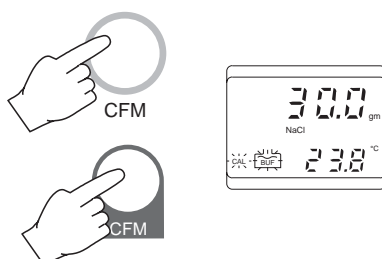

- If the CAL key is pressed at this point, the calibration process is ended providing only one point calibration. For better accuracy however, it is recommended that a two-point calibration is performed.



### **TWO POINT CALIBRATION**

- Proceed as described in "Single Point Calibration" but do not quit calibration by pressing the CAL key.
- After the first point is confirmed, immerse the **FC 300B** electrode into the second buffer solution at 0.3 g/L NaCl (**HI7085/ HI8085**) or 30 g/L NaCl (**HI7081/ HI8081**).



**0.3 g/L or 30 g/L NaCl**

**Note:** the electrode should be immersed approximately 2.5 cm (1") into the solution.

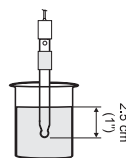

- Select the buffer value by pressing the BUF key. Make sure that the buffer value selected through the BUF key corresponds to the one being used for the second point calibration.

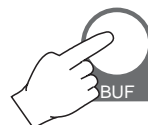

- If the reading is not close to the selected buffer, the "BUF" prompt will blink.

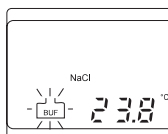

If on the other hand, the reading is close to the selected buffer, the meter will recognize the standard solution. The BUF symbol will stay still on the display, while the "~~~~" symbol will blink, indicating that the meter is stabilizing its reading.

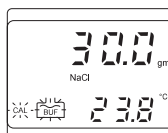

- Once stabilized "CON" symbol will appear on the display.

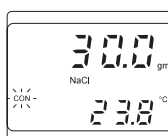

For best results, wait for a couple of minutes and press the CFM key.



- The meter will return to its normal mode and the two point calibration process is completed.

## SPECIAL APPLICATIONS & ADDITIONAL INFORMATION

### HOW TO MEASURE SODIUM CHLORIDE IN CHEESE AND MEAT (HI931100 & HI931102)

1. Take a sample of cheese or meat to be analyzed.
2. Grind the sample.
3. Pour a quantity of X g in a glass beaker. Add (X) x 10mL of deionized water (**note:** ignoring water content in cheese and meat).

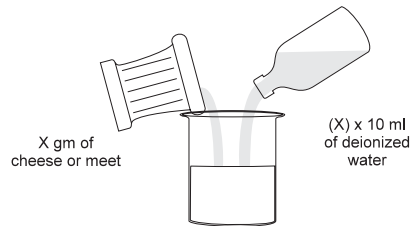
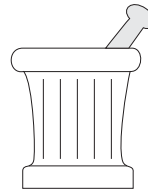

4. Cover the beaker to prevent any spilling during stirring, place the beaker on the top of a hot plate stirrer and agitate the sample at 40-50°C (104-122°F) for 15-20 minutes.

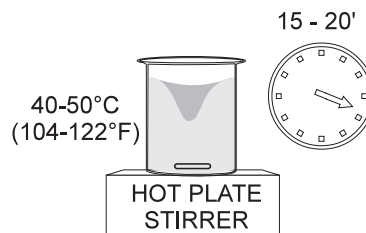

5. Let the sample cool to the ambient temperature, then filter it.

- Dip the sodium electrode **FC300B** into the filtered sample. The tip of the electrode should be immersed for approximately 2.5 cm/1" (i.e. the electrode junction must be completely immersed) without touching the bottom of the beaker. During measurement, the sample should be gently stirred (100 rpm).

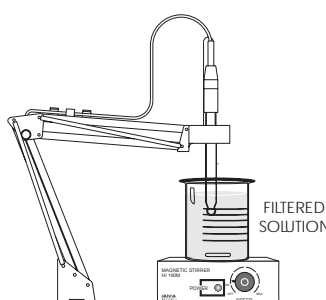

- Wait for the reading to stabilize, i.e. no drift for at least a couple of minutes.

Take note of the measured value.

- Since the dilution rate is 1/10, the reading in the g/L range has to be divided by 100 to get the actual reading of NaCl (per gram of cheese or meat) or it can be considered the value directly expressed in % of NaCl.

**Note:** 10 to 15 minutes as response time, in the first measurement taken in samples of cheese or meat, is the right amount of time needed by the electrode to stabilize. The next measurements in cheese or meat samples will have a shorter response time (less than 2 minutes). Do not rinse the sodium electrode between measurements since contamination is negligible.

### ***IONIC STRENGTH ADJUSTER (ISA)***

It is recommend the use of **HI7090** ISA solution when the NaCl concentration of the sample is lower than 5 g/L. In such case, the calibration of the meters should be performed with standard solution containing 2% of ISA.

**ISA** (Ionic Strength Adjuster) = 50% of NH<sub>4</sub> Cl 4M +50% of NH<sub>4</sub> OH 4M (use 2mL of ISA every 100 mL of sample).

### ***TEMPERATURE***

The best working temperature is around 20-25°C (68-77°F).

For greatest accuracy, we suggest to perform the calibration of the meter with standard solution at a temperature as close as possible to the temperature of the sample (± 1°C/ ±2°F).

### ***Na CONCENTRATION WITH HI 931100 AND HI 931102***

It is always possible to determine the Na concentration by using the formula:

$$X_{Na} = X_{NaCl} \cdot (23 / 58.4)$$

where

$$X_{Na} = \text{Na concentration}$$

and

$$X_{NaCl} = \text{NaCl concentration}$$



## TEMPERATURE CALIBRATION (FOR TECHNICAL PERSONNEL ONLY)

### INITIAL PREPARATION

Prepare a container of ice and water and another container with hot water at a known temperature of 50°C/122°F. Place insulation material around the containers to minimize temperature changes.

Use a Checktemp or a calibrated thermometer with a resolution of 0.1 as reference thermometer.

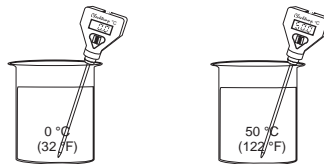

**Note:** A blinking "°C" indicates that the temperature probe is disconnected.

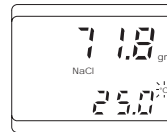

### PROCEDURE

- Connect the temperature probe **HI 7662** to the RCA socket on the top of the instrument.
- Turn the instrument off.

- Press the CAL and the ON/OFF keys simultaneously.

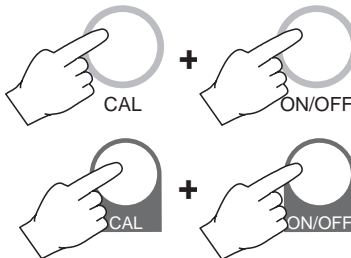

- Immerse the temperature probe into the 0°C (32°F) bath.



- When the reading stabilizes, press the CAL key and the "0.0°C", "CAL" and "BUF" symbols will be displayed. "~~~~" symbol will blink for a few seconds.

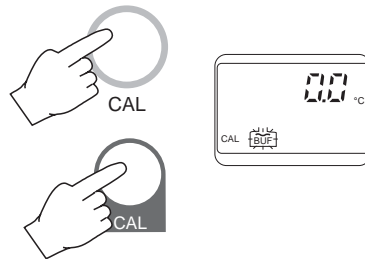

- "~~~~" symbol will disappear from the display when the input value is stable and "CON" will start blinking. Press the CFM key to confirm the calibration value.

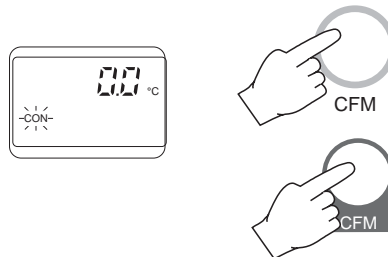

- Immerse the temperature probe into the 50°C (122°F) bath.

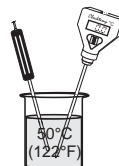

- Press the CAL key to display the "0.0°C" and then press the BUF key to select "50.0°C". "CAL" and "BUF" symbols. "~~~~" symbol will blink for a few seconds

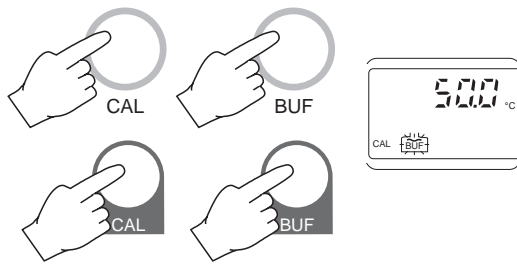

- "~~~~" will disappear from the display when the input value is stable and "CON" will start blinking.

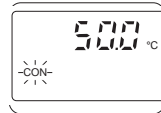

- Press the CFM key to confirm the calibration value.



- The calibration is now complete.



- Turn the meter off and on again to resume the normal operating mode.



**FC300B CONDITIONING & MAINTENANCE**

**PREPARATION**

Remove the protective cap.

DO NOT BE ALARMED IF ANY SALT DEPOSITS ARE PRESENT.

This is normal with sodium electrodes and they will disappear when rinsed with water.

During transport tiny bubbles of air may have formed inside the glass bulb. The electrode cannot function properly under these conditions. These bubbles can be removed by "shaking down" the electrode as you would do with a glass thermometer.

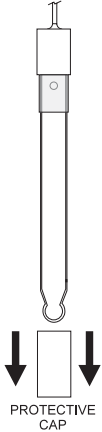

If the bulb and/or junction are dry, soak the electrode overnight in **HI 7081** NaCl 30.0 g/L solution before using with the **HI931100** or **HI931102** sodium meter. Soak it overnight in **HI7086** or **HI8086** Na 23 g/L solution before using with the **HI931101** sodium meter.

If the fill solution (electrolyte) is more than 1 cm (1/2") below the fill

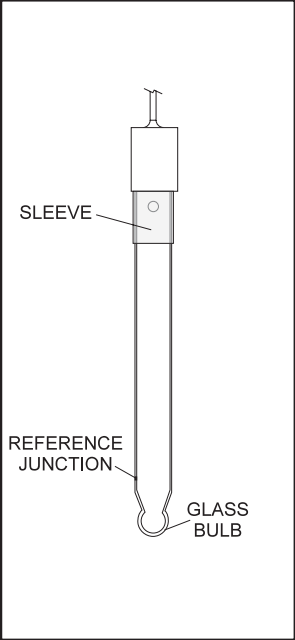

hole, add **HI8093 1M KCl+AgCl Electrolyte Solution**.

Lower the rubber sleeve during measurements and calibration.

### **SODIUM MEASUREMENT**

Rinse the sodium electrode tip with some of the sample to be tested to remove any contamination.

Immerse the tip (2.5 cm /1") in the sample and stir gently.

The sensitive bulb should not touch the bottom of the beaker.

The Hanna **HI76405** electrode holder can be used for this purpose (see page 35).

During measurement, the sample should be gently stirred (approx. 100 rpm). The Hanna **HI190M** stirrer can be used for this purpose (see page 34).

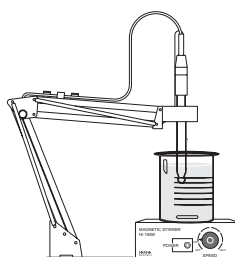
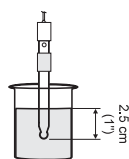

### **STORAGE**

When used frequently, the electrode should be stored in a solution with a Na or NaCl concentration similar to the sample to be measured. For longer periods of storage, the electrode should be capped with a few drops of appropriate solution.

For frequent use in different samples (1 or 2 times per week), store the electrode in **HI7081** or **HI8081** (30.0 g/L NaCl) if used for NaCl measurements (in conjunction with **HI931100** or **HI931102**).

Store the electrode in **HI7080** or **HI8080** (2.3 g/L Na) if used for Na measurements (in conjunction with **HI931101**).

For occasional use (once a month or less) store the electrode dry and let it conditioning overnight in **HI7081** or **HI8081** (30.0 g/L NaCl) or **HI7086** or **HI8086** (23 g/L Na) before use.

**Note: NEVER STORE OR RINSE THE ELECTRODE IN DISTILLED OR DEIONIZED WATER.**

#### ***PERIODIC MAINTENANCE***

Inspect the electrode and the cable. The cable used for connection to the meter must be intact and there must be no points of broken insulation on the cable or cracks on the electrode stem or bulb. Connectors must be perfectly clean and dry.

If any scratches or cracks are present, replace the electrode.

Rinse off any salt deposits with water.

Refill the electrode with fresh electrolyte (**HI8093**) and let it stand upright for 1 hour.

Follow the Storage Procedure above.

#### ***CLEANING PROCEDURE***

General      Soak in Hanna **HI7061** or **HI8061** **General Cleaning Solution** for approximately 1 hour.

Removal of films, dirt or deposits on the membrane/junction:

- *Protein* Soak in Hanna **HI 7073 or HI 8073 Protein Cleaning Solution** for 15 minutes.
- *Inorganic* Soak in Hanna **HI 7074 or HI 8074 Inorganic Cleaning Solution** for 15 minutes.
- *Oil/grease* Rinse with Hanna **HI 7077 or HI 8077 Oil and Fat Cleaning Solution**.

**IMPORTANT:** After performing any of the cleaning procedures rinse the electrode thoroughly with a solution containing 2% ISA (see page 22), refill (if necessary) the reference chamber with fresh electrolyte (**HI 8093**) and soak the electrode in **a solution very close to the next sample to be measured** for at least 1 hour before taking measurements.

**NEVER RUB OR BLOT DRY  
THE ELECTRODE.**

#### ***TROUBLESHOOTING***

Evaluate your electrode performance based on the following.

- **Noise** (Readings fluctuate up and down) could be due to:
  - **Clogged/Dirty Junction:** Refer to the Cleaning Procedure above.
  - **Loss of shielding** due to low electrolyte level: **HI 8093**

- **Dry Membrane/Junction:** Soak it overnight in **HI7081** or **HI8081** (30.0 g/L NaCl) or **HI7086** or **HI8086** (23 g/L Na) before use.
- **Drifting:** Soak the electrode tip in warm Hanna Solution **HI 8093** for one hour. Refill with fresh **HI 8093** electrolyte solution.
- **Low Slope:** Refer to the cleaning procedure above.
- **No Slope:** Check the electrode for cracks in glass stem or bulb and replace the electrode.
- **Slow Response/Excessive Drift:** Soak the tip in Hanna Solution **HI 7061** or **HI 8061** for 30 minutes, rinse thoroughly in a solution with 2% of ISA (see page 22) and then follow the Cleaning Procedure above.



## BATTERY REPLACEMENT

If the batteries become weak the LCD will display "LOW BAT".

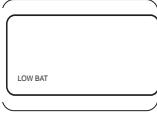

Battery replacement must only take place in a non hazardous area using the battery types specified in this instruction manual (see page 34).

To replace rundown batteries, remove the two screws in the rear cover of the instrument and replace all the 1.5V AA batteries with new ones, paying attention to the correct polarity. Replace the cover and tighten the two screws.

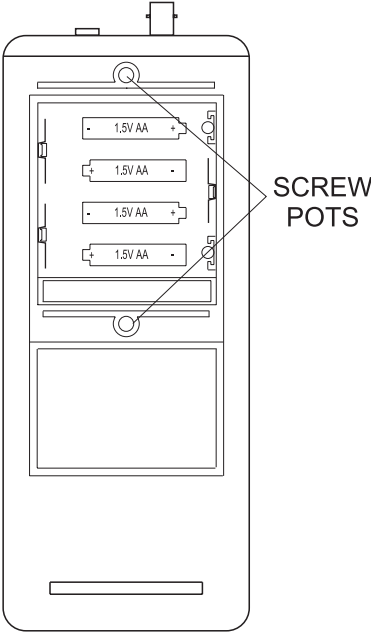

## ACCESSORIES

### ***Na CALIBRATION (& STORAGE) SOLUTIONS FOR HI931101:***

<b>HI 7080M</b>	2.3 g/L Na solution, 230 mL
<b>HI 7080L</b>	2.3 g/L Na solution, 460 mL
<b>HI 7086M</b>	23 g/L Na solution, 230 mL
<b>HI 7086L</b>	23 g/L Na solution, 460 mL
<b>HI 7087M</b>	0.230 g/L Na solution, 230 mL
<b>HI 7087L</b>	0.230 g/L Na solution, 460 mL

### ***Na CALIBRATION (& STORAGE) SOLUTIONS IN FDA APPROVED BOTTLES FOR HI931101:***

<b>HI 8080M</b>	2.3 g/L Na solution, 230 mL
<b>HI 8080L</b>	2.3 g/L Na solution, 460 mL
<b>HI 8086M</b>	23 g/L Na solution, 230 mL
<b>HI 8086L</b>	23 g/L Na solution, 460 mL
<b>HI 8087M</b>	0.230 g/L Na solution, 230 mL
<b>HI 8087L</b>	0.230 g/L Na solution, 460 mL

### ***NaCl CALIBRATION (& STORAGE) SOLUTIONS FOR HI 931100 & HI 931102:***

<b>HI 7081M</b>	30 g/L NaCl solution, 230 mL
<b>HI 7081L</b>	30 g/L NaCl solution, 460 mL
<b>HI 7083M</b>	3.0 g/L NaCl solution, 230 mL
<b>HI 7083L</b>	3.0 g/L NaCl solution, 460 mL
<b>HI 7085M</b>	0.3 g/L NaCl solution, 230 mL

**HI 7085L** 0.3 g/L NaCl solution, 460 mL  
**HI 7090M** ISA solution, 230 mL  
**HI 7090L** ISA solution, 460 mL

***NaCl CALIBRATION (& STORAGE) SOLUTIONS IN FDA APPROVED BOTTLES FOR HI 931100 & HI 931102:***

**HI 8081M** 30 g/L NaCl solution, 230 mL  
**HI 8081L** 30 g/L NaCl solution, 460 mL  
**HI 8083M** 3.0 g/L NaCl solution, 230 mL  
**HI 8083L** 3.0 g/L NaCl solution, 460 mL  
**HI 8085M** 0.3 g/L NaCl solution, 230 mL  
**HI 8085L** 0.3 g/L NaCl solution, 460 mL  
**HI 8090M** ISA solution, 230 mL  
**HI 8090L** ISA solution, 460 mL

***ELECTRODE CLEANING SOLUTIONS:***

**HI7061M** General Cleaning Sol., 230 mL  
**HI7061L** General Cleaning Sol., 460 mL  
**HI7073M** Protein Cleaning Sol., 230 mL  
**HI7073L** Protein Cleaning Sol., 460 mL  
**HI7074M** Inorganic Cleaning Sol., 230 mL  
**HI7074L** Inorganic Cleaning Sol., 460 mL  
**HI7077M** Oil & Fat Cleaning Sol., 230 mL  
**HI7077L** Oil & Fat Cleaning Sol., 460 mL

***ELECTRODE CLEANING SOLUTIONS IN  
FDA APPROVED BOTTLES:***

<b>HI 8061M</b>	General Cleaning Solution, 230 mL
<b>HI 8061L</b>	General Cleaning Solution, 460 mL
<b>HI 8073M</b>	Protein Cleaning Solution, 230 mL
<b>HI 8073L</b>	Protein Cleaning Solution, 230 mL
<b>HI 8077M</b>	Oil & Fat Cleaning Solution, 230mL
<b>HI 8077L</b>	Oil & Fat Cleaning Solution, 460mL

***REFILLING ELECTROLYTE SOLUTION IN  
FDA APPROVED BOTTLE:***

<b>HI 8093</b>	1M KCl + AgCl Electrolyte, 4x50mL
----------------	-----------------------------------

***OTHER ACCESSORIES:***

<b>ChecktempC</b>	Pocket-size thermometer with penetration probe and 0.1°C resolution (range -50.0 to 150.0°C)
<b>FC 300B</b>	Sodium electrode, glass body, single junction, refillable, with 1 meter (3.3') cable
<b>HI 190M/D</b>	Mini-stirrer 220V (max. stirring capacity 1 liter, speed range min. 100 max. 1000 rpm)
<b>HI 190M/U</b>	Mini-stirrer 115V (max. stirring capacity 1 liter, speed range min. 100 max. 1000 rpm)

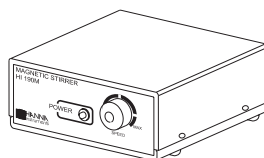

- HI 710031** Rugged carrying case
- HI 721308** 1.5V AA alkaline battery (10 pcs)
- HI 7662** Temperature probe with 1 m (3.3') cable
- HI 76405** Electrode holder

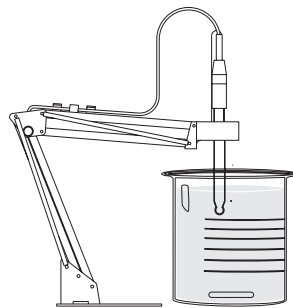

- MANNACLR1** Instruction manual

## WARRANTY

All Hanna Instruments **meters are warranted for two years** against defects in workmanship and materials when used for their intended purpose and maintained according to instructions.

**The electrodes and the probes are warranted for a period of six months.**

This warranty is limited to repair or replacement free of charge.

Damages due to accident, misuse, tampering or lack of prescribed maintenance are not covered.

If service is required, contact the dealer from whom you purchased the instrument. If under warranty, report the model number, date of purchase, serial number and the nature of the failure. If the repair is not covered by the warranty, you will be notified of the charges incurred. If the instrument is to be returned to Hanna Instruments, first obtain a Returned Goods Authorization Number from the Customer Service department and then send it with shipment costs prepaid. When shipping any instrument, make sure it is properly packaged for complete protection.

To validate your warranty, fill out and return the enclosed warranty card within 14 days from the date of purchase.

*All rights are reserved. Reproduction in whole or in part is prohibited without the written consent of the copyright owner.*

Hanna Instruments reserves the right to modify the design, construction and appearance of its products without advance notice.

**CE DECLARATION OF CONFORMITY**



**CE**

DECLARATION OF CONFORMITY

We

Hanna Instruments Srl  
V.le delle industrie 12  
35010 Ronchi di Villafranca (PD)  
ITALY

herewith certify that the meters

**HI 931100 HI 931101 HI 931102**

have been tested and found to be in compliance with the following regulations:

<b>IEC 801-2</b>	Electrostatic Discharge
<b>IEC 801-3</b>	RF Radiated
<b>EN 55022</b>	Radiated, Class B

Date of Issue: 13-03-1996

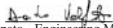
  
D. Volpato - Engineering Manager  
On behalf of  
Hanna Instruments S.r.l.

**Recommendations for Users**

Before using these products, make sure that they are entirely suitable for the environment in which they are used.

Operation of these instruments in residential area could cause unacceptable interferences to radio and TV equipments, requiring the operator to take all necessary steps to correct interferences.

Any variation introduced by the user to the supplied equipment may degrade the instruments' EMC performance.

To avoid electrical shock, do not use these instruments when voltages at the measurement surface exceed 24VAC or 60VDC.

To avoid damages or burns, do not perform any measurement in microwave ovens.

PRINTED IN  
ITALY

MANNA CLR1  
03/96



<http://www.hannain.com>