



**HI 700**

**HI 705**

**HI 710**

---

Process,  
Panel-mounted,  
Microprocessor-based,  
Conductivity and TDS  
Controllers

Instruction Manual

Dear Customer,

Thank you for choosing a Hanna Product.

This instruction manual has been written for the following products:

- HI 700**      EC controller with dual setpoint, ON/OFF and PID control, analog output
- HI 705**      TDS controller with dual setpoint, ON/OFF and PID control, analog output
- HI 710**      EC and TDS controller with dual setpoint, ON/OFF and PID control, analog output

Please read this instruction manual carefully before using the instrument. It will provide you with the necessary information for the correct use of the instrument, as well as a precise idea of its versatility.

These instruments are in compliance with **CE** directives EN 50081-1, EN 50082-1 and EN 61010-1.

© Hanna Instruments

All rights are reserved. Reproduction in whole or in part is prohibited without the written consent of the copyright owner, Hanna Instruments Inc.



## TABLE OF CONTENTS

---

PRELIMINARY EXAMINATION . . . . .	4
GENERAL DESCRIPTION . . . . .	4
FUNCTIONAL DESCRIPTION . . . . .	6
MECHANICAL DIMENSIONS . . . . .	7
SPECIFICATIONS . . . . .	8
INSTALLATION . . . . .	9
SETUP MODE . . . . .	12
CONTROL MODE . . . . .	18
IDLE MODE . . . . .	26
ANALOG OUTPUT . . . . .	27
CALIBRATION . . . . .	28
LAST CALIBRATION DATA . . . . .	36
FAULT CONDITIONS AND SELFTEST PROCEDURES . . . . .	37
EXTERNAL FUNCTIONS . . . . .	40
STARTUP . . . . .	41
EC VALUES AT VARIOUS TEMPERATURES . . . . .	42
EC/TDS PROBE MAINTENANCE . . . . .	43
ACCESSORIES . . . . .	44
WARRANTY . . . . .	46
CE DECLARATION OF CONFORMITY . . . . .	47

## PRELIMINARY EXAMINATION

---

Remove the instrument from the packing material and examine it carefully to make sure that no damage has occurred during shipping. If there is any noticeable damage, notify your Dealer or the nearest Hanna Customer Service Center immediately.

**Note** Save all packing materials until you are sure that the instrument functions correctly. Any damaged or defective items must be returned in their original packing materials together with the supplied accessories.

## GENERAL DESCRIPTION

---

HI 700, HI 705 and HI 710 are real time microprocessor-based EC or TDS controllers. They provide accurate measurements, flexible ON/OFF or proportional control capabilities, analog input and output, dual setpoint and alarm signal.

The system is composed of a case inside which the signal conversion circuitry, the microprocessor circuitry and the output power drivers are contained.

### MAIN FEATURES OF DIFFERENT MODELS

- Display: large LCD with 4 ½ 17 mm digits and 3 ½ 10 mm digits.
- LEDs: four LEDs are provided for signaling the energizing of relay 1 and 2 (yellow LEDs) and alarm relays (a green and a red LED).
- Relays: 1 or 2 output relays for low conductivity or high conductivity dosage (COM, NO and NC contacts) and 1 output relay for alarm condition (COM, NO and NC contacts).
- Calibration and Setup procedures allowed only through an unlock password.
- Calibration: 2 points with Hanna EC and TDS calibration solutions.
- Four different EC working ranges (0 to 199.9µS; 0 to 1999µS; 0 to 19.99mS; 0 to 199.9mS) for HI 700 and HI 710 models.

- Four different TDS working ranges (0 to 100.0ppm; 0 to 1000ppm; 0 to 10.00ppm; 0 to 100.0ppm) for HI 705 model.
- Possibility to switch to TDS measurements with conversion factor from 0.00 to 1.00 (HI 710 only).
- Temperature compensation of the HANNA standard solutions.
- Temperature compensation of the EC and TDS reading with temperature coefficient  $\beta$  selectable from 0 to 10%/°C.
- Manual temperature setting when the temperature probe is not inserted or temperature exceeds the upper range.
- Last calibration data internally recorded (non-volatile EEPROM memory): calibration date and time, cell constant, calibration solution values.
- Input: 4-ring EC/TDS probe with cell constant  $2.0 \pm 10\%$ , or 4-20mA analog input from a transmitter.
- Output:
  - isolated 0-1 mA, 10 K $\Omega$  maximum load (optional);
  - isolated 0-20 mA, 750  $\Omega$  maximum load (optional);
  - isolated 4-20 mA, 750  $\Omega$  maximum load (optional);
  - isolated 0-5 VDC, 1 K $\Omega$  minimum load (optional);
  - isolated 1-5 VDC, 1 K $\Omega$  minimum load (optional);
  - isolated 0-10 VDC, 1 K $\Omega$  minimum load (optional).
- Real time clock.

# FUNCTIONAL DESCRIPTION

## FRONT PANEL

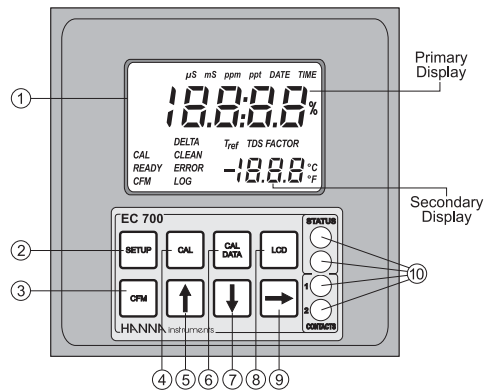

1. Liquid Crystal Display
2. SETUP key enters setup mode
3. CFM key confirms current choice (and skips to the next item)
4. CAL key initiates and exits calibration mode
5. ↑ key increases the blinking digit/letter by one when selecting a parameter. Advances forward while in last calibration data viewing mode. Increases the temperature setting when temperature probe is not inserted
6. CAL DATA key last calibration data viewing (enters and exits)
7. ↓ key decreases the blinking digit/letter by one when selecting a parameter. Reverts backward while in last calibration data viewing mode. Decreases the temperature setting when temperature probe is not inserted
8. LCD key exits from setup and reverts back to normal mode (in idle or control phases with the measurement on the display). During EC/TDS calibration, it alternates EC/TDS buffer value and current cell constant on the display. In HI 710 model only, it switches between EC and TDS reading
9. ⇒ key moves to the next digit/letter (circular solution) when selecting a parameter. Same as ↑ key during last calibration data viewing mode
10. LEDs

## REAR PANEL

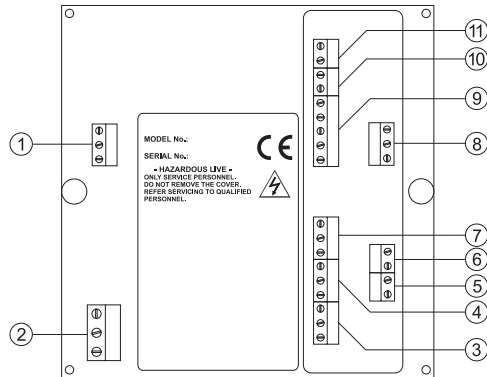

1. Analog Output
2. Power Supply
3. Alarm Terminal
4. Contact 2 - Second Dosing Terminal
5. Timer
6. Hold
7. Contact 1 - First Dosing Terminal
8. Pt 100 Temperature Sensor connector
9. EC/TDS probe connector
10. Power supply output for external transmitter
11. 4-20 mA input from external transmitter

 Unplug the meter before any electrical connection.

## MECHANICAL DIMENSIONS

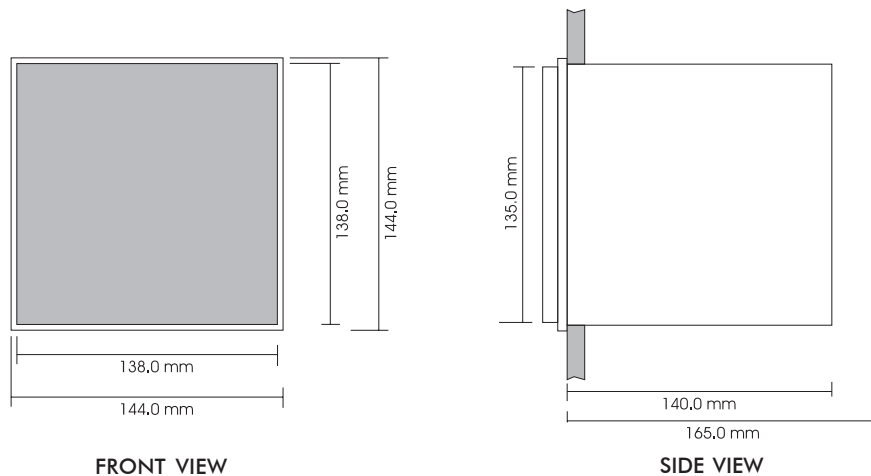

## SPECIFICATIONS

<b>Ranges</b>	0.0 to 199.9 $\mu$ S, 0 to 1999 $\mu$ S (HI 700, HI 710 only) 0.00 to 19.99 mS, 0.0 to 199.9 mS (HI 700, HI 710 only) 0.0 to 100.0 ppm, 0 to 1000 ppm (HI 705, HI 710* only) 0.00 to 10.00 ppt, 0.0 to 100.0 ppt (HI 705, HI 710* only) -10.0 to 100.0 °C
<b>Resolution</b>	0.1 $\mu$ S, 1 $\mu$ S (HI 700, HI 710 only) 0.01 mS, 0.1 mS (HI 700, HI 710 only) 0.1 ppm, 1 ppm (HI 705, HI 710 only) 0.01 ppm, 0.1 ppm (HI 705, HI 710 only) 0.1 °C
<b>Accuracy</b> (@20°C/68°F)	$\pm 0.5\%$ full scale (EC and TDS) $\pm 0.5^\circ\text{C}$ between 0 to 70°C, $\pm 1^\circ\text{C}$ outside
<b>Temperature Compensation</b>	Automatic from -10 to 100°C or manual with Temperature Coefficient from 0.00 to 10.00%/°C
<b>Typical EMC Deviation</b>	$\pm 2\%$ full scale (EC and TDS) $\pm 0.5^\circ\text{C}$
<b>Installation Category</b>	II
<b>Probe</b>	<b>HI 7639</b> 4-ring EC/TDS probe (K=2) with built-in 3-wire PT100 temperature sensor and 5 mt shielded cable
<b>Analog Input</b>	4 - 20 mA
<b>Power Supply</b>	230 $\pm 10\%$ VAC or 115 $\pm 10\%$ VAC, 50/60 Hz
<b>Power Consumption</b>	10 VA
<b>Over Current Protection</b>	200 mA 250V FAST FUSE
<b>Relays 1 and 2</b>	<ul style="list-style-type: none"> <li>Electromechanical relay SPDT contact outputs, 5A-250 VAC, 5A - 30 VDC (resistive load)</li> </ul>
<b>Alarm Relay</b>	<ul style="list-style-type: none"> <li>Electromechanical Relay SPDT contact output, 5A - 250 VAC, 5A - 30 VDC (resistive load)</li> </ul>
<b>Environment</b>	0-50 °C; max 95% R.H. non-condensing
<b>Enclosure</b>	single case ½ DIN
<b>Weight</b>	approximately 1.6 kg. (3.5 lb.)

\* Note: actual TDS range for HI 710 depends on TDS factor set.



# INSTALLATION

EC 700, TDS 705 and EC 710 offer a multitude of possibilities, from single and dual setpoints to ON/OFF or PID dosage, isolated outputs with user-selectable zoom, recorder outputs in mAmps and volts.

Use the 3-wire Pt 100 temperature sensor to compensate for the cable resistance and have a precise automatic temperature compensation of the measurements in long distance applications.

See the diagram for a recommended installation.

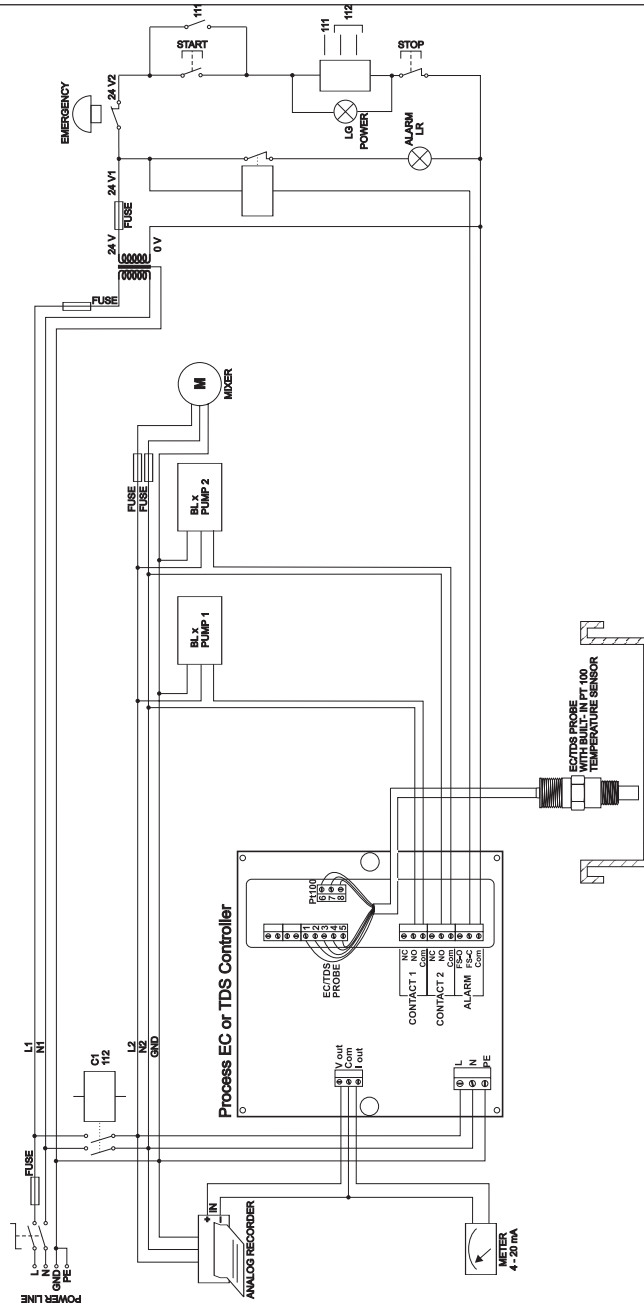

- Power Supply: Connect a 3-wire power cable to the terminal strip, while paying attention to the correct live (L), earth (PE) and neutral (N) terminal connections.



Power: 115VAC - 100 mA / 230VAC - 50 mA.

Live Contact: fused inside 200mA.

PE leakage current 1 mA; this contact must be connected to ground.

- Conductivity input: the default input is from conductivity probe. Connect the EC probe to the terminals #9 on page 7. Connect the cable shield to pin 1, and the other four wires according to the following table:

Color	Pin #	EC / TDS PROBE
		1 (Shield)
GREEN	2	2
WHITE	3	3
RED	4	4
BLUE	5	5

- Pt 100 Terminals: these contacts (#8 on page 7) connect the Pt 100 temperature sensor for automatic temperature compensation of measurement. The **HI7639** EC/TDS probe has a built-in 3-wire Pt 100 sensor to be connected according to the following table:

Color	Pin #	Pt 100
GRAY	6	6
BROWN	7	7
YELLOW	8	8

If using a different Pt 100, connect it as explained below.

In the case of a 2-wire sensor connect the Pt 100 to pins 1 and 3, and short pins 2 and 3 with a jumper wire.

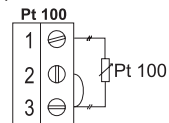

If the Pt 100 has more than 2 wires, connect the two wires of one end to pins 2 and 3 (pin 2 is an auxiliary input to compensate for the cable resistance) and one wire from the other end to pin 1. Leave the fourth wire unconnected, if present.

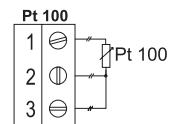

**Note** If the meter does not detect the temperature probe, it will switch automatically to manual temperature compensation with the temperature adjustable through the up and down arrow keys. The “°C” symbol will blink on the LCD.

**Note** All external cables to be connected to the rear panel should be ended with cable lugs.

- Analog output: Connect an external recorder with a 2-wire cable to these terminals (#1 on page 7) paying attention to the correct polarity. A wide variety of output signals, either in V or in mA, is available to fit most standards.
- Contact 1 and 2: Connect the dosing devices to these terminals (#4 and #7 on page 7) in order to activate and deactivate them according to the selected control parameters.

- mA Input: to switch to mA input signal from a conductivity transmitter (e.g. HI8936, HI98143 or HI98144 series) see setup procedure (code 6). Connect the two signal wires from the transmitter to terminals #11 on page 7, paying attention to the correct polarity.

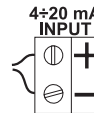

An unregulated 10 ÷ 30 VDC - 50 mA max. power supply output (#10 on page 7) is provided to power the transmitter, if needed.

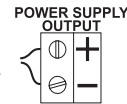

Once the installation is completed, select the appropriate working range, the reference temperature (20 or 25°C) and perform conductivity or TDS calibration as described in this instruction manual. Set the control parameters according to the process.

## SETUP MODE

---

HI 700, HI 705 and HI 710 offer a multitude of possibilities from ON/OFF or PID dosage to analog recorder output and from alarm to selftest features.

The Setup Mode allows the user to set all needed characteristics of the meter.

The setup mode is entered by pressing SETUP and entering the password when the device is in idle or control mode.



Generally speaking, if the password is not inserted the user can only view the setup parameters (except for password) without modifying them (and the device remains in control mode). An exception is certain setup items, or flags, which can activate special tasks when set and confirmed.

Each setup parameter (or setup item) is assigned a two-digit setup code which is entered and displayed on the secondary LCD.

The setup codes can be selected after password and CFM are pressed. When CFM is pressed, the current setup item is saved on EEPROM and the following item is displayed. Whenever LCD is pressed, the device reverts back to control mode. The same is true when CFM is pressed on the last setup item.



The possible transitions in setup mode are the following:

### ENTERING THE PASSWORD

- Press SETUP to enter the setup mode. The LCD will display "0000" on the upper part and "PAS" on the lower. The first digit of the upper part of the LCD will blink.

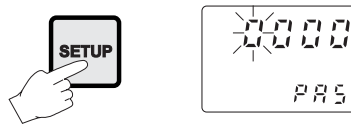

- Enter the first value of the password by the ↑ or ↓ keys.



- Then confirm the displayed digit with  $\Rightarrow$  and move to the next one.



- When the whole password has been inserted, press CFM to confirm it.



**Note**

The default password is set at "0000".

- The LCD will display "SET" on the upper part and "c.00" on the lower, allowing the user to edit setup parameters (see table below).

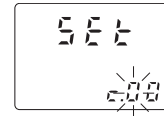

- Enter the code of the parameter you want to set, using the arrow keys as per the password procedure above (e.g. 41).
- Confirm the code by pressing CFM and the default or the previously memorized value will be displayed with the first digit blinking.

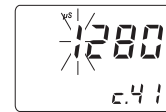

**Note**

When the password is not inserted or a wrong password is confirmed, the display will only show the previously memorized value, without blinking (read only mode). In this case, the value cannot be set. Press LCD and start again.

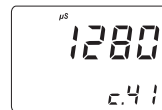

- Enter the desired value using the arrow keys and then press CFM.

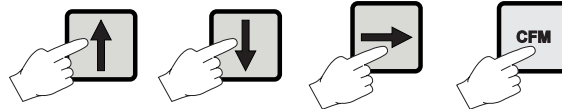

- After confirmation, the selected parameter is displayed. The user can scroll through the parameters by pressing CFM.



In order to directly set another parameter, press SETUP again and enter the code or scroll to it by pressing CFM.



The following table lists the setup codes along with the description of the specific setup items, their valid values and whether password is required to view that item ("PW" column):

Code	Valid Values	Default	PW
00 Factory ID	0 to 9999	0000	no
01 Process ID	0 to 9999	0000	no
02 Control enable/disable	0: C.M. disabled 1: C.M. enabled	0	no
03 Range (depends on model)	1: 0.0-199.9 $\mu$ S (or 100.0 ppm) 2: 0-1999 $\mu$ S (or 1000 ppm) 3: 0.00-19.99 mS (or 10.00 ppt) 4: 0.0-199.9 mS (or 100.0 ppt)	4	no
04 Reference Temperature	20°C or 25°C	25°C	no
05 Temperature Coefficient	0.00 to 10.00 %/°C	2.00	no
06 Input Selection	0: conductivity probe 1: 4-20 mA input signal	0	no
07 Temperature compensation	ATC: Automatic User: Manual	ATC	no
08 TDS Factor (HI 710 only)	0.00 to 1.00	0.50	no
11 Relay 1 mode (M1)	0: disabled 1: ON-OFF high setpoint 2: ON-OFF low setpoint 3: PID, high setpoint 4: PID, low setpoint	0	no
12 Relay 1 setpoint (S1)	0.5 to 99.5% full scale	25% f.s.	no
13 Relay 1 hysteresis (H1)	0 to 5% f.s.	1% f.s.	no

Code	Valid Values	Default	PW
14 Relay 1 deviation (D1)	0.5 to 10% f.s.	1% f.s.	no
15 Relay 1 reset time	0.1 to 999.9 minutes	999.9	no
16 Relay 1 rate time	0.0 to 999.9 minutes	0.0	no
21 Relay 2 mode (M2)	same as relay 1	0	no
22 Relay 2 setpoint (S2)	0.5 to 99.5% full scale	75% f.s.	no
23 Relay 2 hysteresis (H2)	0 to 5% f.s.	1% f.s.	no
24 Relay 2 deviation (D2)	0.5 to 10% f.s.	1% f.s.	no
25 Relay 2 reset time	0.1 to 999.9 minutes	999.9	no
26 Relay 2 rate time	0.0 to 999.9 minutes	0.0	no
30 Relay 3 high alarm (HA)	0.5 to 99.5% full scale HA-Hys $\geq$ LA+Hys,Hys=1.5%f.s.,HA $\geq$ S1 or HA $\geq$ S2	95% f.s.	no
31 Relay 3 low alarm (LA)	0.5 to 99.5% full scale LA+Hys $\leq$ HA-Hys,Hys=1.5%f.s.,LA $\leq$ S1 or LA $\leq$ S2	5% f.s.	no
32 Proportional control mode period	1 to 30 min	5	no
33 Maximum relay ON time (after which an alarm mode is entered)	1 to 10 min	10	no
34 Alarm mask time	00:00 to 30:00	00:00	no
40 Analog output selection	0: 0-1mA 1: 0-20 mA 2: 4-20 mA 3: 0-5 VDC 4: 1-5 VDC 5: 0-10 VDC	2	no
41 Analog output lower limit (O_VARMIN)	0 to 100% full scale (O_VARMIN $\leq$ O_VARMAX - 5% f.s.)	0	no
42 Analog output upper limit (O_VARMAX)	0 to 100% full scale (O_VARMIN $\leq$ O_VARMAX - 5% f.s.)	100% f.s.	no

Code	Valid Values	Default	PW
60 Current day	01 to 31	from RTC	no
61 Current month	01 to 12	from RTC	no
62 Current year	1998 to 9999	from RTC	no
63 Current time	00:00 to 23:59	from RTC	no
72 Cleaning timer	0 to 9999 days	0	no
73 Initial cleaning day	01 to 31	01	no
74 Initial cleaning month	01 to 12	01	no
75 Initial cleaning year	1998 to 9999	1998	no
76 Initial cleaning time	00:00 to 23:59	00:00	no
77 Cleaning ON interval	0 to 19999 minutes	0	no
90 Display selftest	0: off 1: on	0	yes
91 Keyboard selftest	0: off 1: on	0	yes
92 EEPROM selftest	0: off 1: on	0	yes
93 Relays and LEDs selftest	0: off 1: on	0	yes
94 Watchdog selftest	0: off 1: on	0	yes
99 Unlock password	0000 to 9999	0000	yes

**Note** The process controller automatically checks to ensure that the entered data matches other related variables. If a wrong configuration is entered, "ERROR" blinks on the LCD to prompt the user. The correct configurations are the following:

If  $M1 \neq 0$  then  $S1 \leq HA$ ,  $S1 \geq LA$ ;

If  $M2 \neq 0$  then  $S2 \leq HA$ ,  $S2 \geq LA$ ;

If  $M1 = 1$  then  $S1 - H1 \geq LA$ ;

If  $M1 = 2$  then  $S1 + H1 \leq HA$ ;

If  $M1 = 3$  then  $S1 + D1 \leq HA$ ;



If  $M1 = 4$  then  $S1 - D1 \geq LA$ ;  
 If  $M2 = 1$  then  $S2 - H2 \geq LA$ ;  
 If  $M2 = 2$  then  $S2 + H2 \leq HA$ ;  
 If  $M2 = 3$  then  $S2 + D2 \leq HA$ ;  
 If  $M2 = 4$  then  $S2 - D2 \geq LA$ ;  
 If  $M1 = 1$  and  $M2 = 2$   
 then  $S1 - H1 \geq S2 + H2$ ,  $S2 \geq LA$ ,  $HA \geq S1$ ;  
 If  $M1 = 2$  and  $M2 = 1$   
 then  $S2 - H2 \geq S1 + H1$ ,  $S1 \geq LA$ ,  $HA \geq S2$ ;  
 If  $M1 = 3$  and  $M2 = 2$   
 then  $S1 \geq S2 + H2$ ,  $S2 \geq LA$ ,  $HA \geq S1 + D1$ ;  
 If  $M1 = 2$  and  $M2 = 3$   
 then  $S1 + H1 \leq S2$ ,  $S1 \geq LA$ ,  $HA \geq S2 + D2$ ;  
 If  $M1 = 4$  and  $M2 = 1$   
 then  $S1 < S2 - H2$ ,  $S1 - D1 \geq LA$ ,  $HA \geq S2$ ;  
 If  $M1 = 1$  and  $M2 = 4$   
 then  $S1 - H1 \geq S2$ ,  $S2 - D2 \geq LA$ ,  $HA \geq S1$ ;  
 If  $M1 = 3$  and  $M2 = 4$   
 then  $S1 \geq S2$ ,  $S2 - D2 \geq LA$ ,  $HA \geq S1 + D1$ ;  
 If  $M1 = 4$  and  $M2 = 3$   
 then  $S2 \geq S1$ ,  $S1 - D1 \geq LA$ ,  $HA \geq S2 + D2$ ;  
 where the minimum deviation ( $D1$  or  $D2$ ) is 0.5% of the maximum range value.

**Note** When a wrong setup value is confirmed, the controller does not skip to the next setup item but remains in the current item displaying a flashing "ERROR" indicator until the parameter value is changed by the user (the same is also true for the setup code selection).



**Note** In some circumstances, the user cannot succeed in setting a parameter to a desired value if the related parameters are not changed beforehand; e.g. to set a EC high setpoint to 10.0 mS the high alarm must be set to a value greater than 10.0 mS first.

## CONTROL MODE

The control mode is the normal operational mode for these meters. During control mode the meter fulfills the following main tasks:

- converts information from EC/TDS and temperature inputs to digital values;
- controls relays and generates the analog outputs as determined by the setup configuration, displays alarm condition;

In HI 710 model it is possible to switch between EC and TDS reading pressing "LCD". The TDS value is obtained multiplying the EC measurement by the TDS factor set through setup. The HI 700 displays EC only. The HI 705 displays TDS only, with a TDS factor fixed at 0.5.

The status of the meter is shown by the LED's on the right.

STATUS	LEDs			
	Control	Alarm	Alarm LED (green)	Relay LED (yellow)
OFF	---	ON	OFF	ON
ON	OFF	ON	ON or OFF	OFF
ON	ON	OFF	ON or OFF	Blinking

Meter exits control mode by pressing SETUP or CAL and confirming the password. Note that this command generates a temporary exit. To deactivate the control mode definitively, set CONTROL ENABLE to "0" (item # 02).

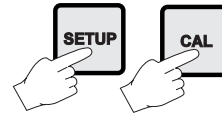

## RELAY MODES

Once enabled, the relays 1 and 2 can be used in four different modes):

- 1) ON/OFF, high setpoint (low conductivity dosage);
- 2) ON/OFF, low setpoint (high conductivity dosage);
- 3) PID, low setpoint (low conductivity dosage);
- 4) PID, high setpoint (high conductivity dosage).

An upper boundary is imposed for dosage time when relays are energized continuously, i.e. when relay works in ON/OFF mode or also in PID mode but in the latter case only if the relay is always ON. This parameter can be set through setup procedure. When the maximum boundary is reached, an alarm is generated; device stays in alarm condition until relay is de-energized.

### ON/OFF CONTROL MODE

Either for mode 1 or 2 (high or low conductivity dosage) the user has to define the following values through setup:

- relay setpoint ( $\mu\text{S}/\text{mS}/\text{ppm}$  value);
- relay hysteresis ( $\mu\text{S}/\text{mS}/\text{ppm}$  value).

Connect your device to the COM and NO (Normally Open) or NC (Normally Closed) terminals.

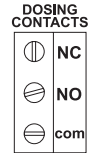

The ON relay state occurs when relay is energized (NO and COM connected, NC and COM disconnected).

The OFF relay state occurs when relay is de-energized (NO and COM disconnected, NC and COM connected).

The following graphs show relay states along with EC measured value (similar graph can be derived for TDS control).

As shown below, a high setpoint relay is activated when the measured EC exceeds the setpoint and is deactivated when it is below the setpoint value minus hysteresis.

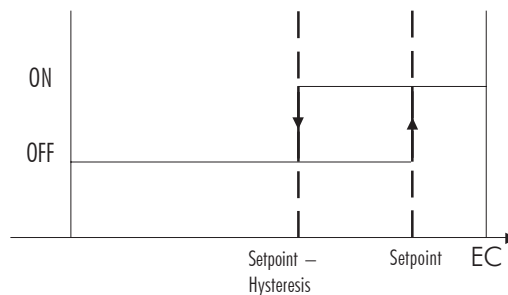

Such a behavior is suitable to control a high conductivity dosing pump.

A low setpoint relay as can be seen from the following graphs is energized when the EC value is below the setpoint and is de-energized when the EC value is above the sum of setpoint and the hysteresis. The low setpoint relay may be used to

control a low conductivity dosing pump.

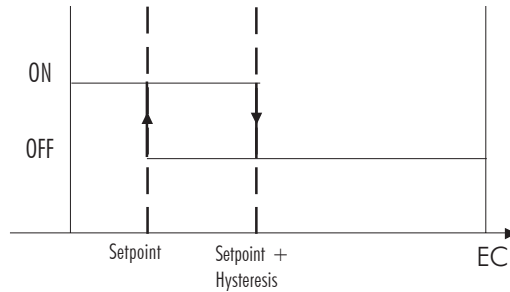

#### PI.D. CONTROL MODE

PID control is designed to eliminate the cycling associated with ON/OFF control in a rapid and steady way by means of the combination of the proportional, integral and derivative control methods.

With the proportional function, the duration of the activated control is proportional to the error value (Duty Cycle Control Mode): as the measurement approaches setpoint, the ON period diminishes.

The following graph describes the EC/TDS process controller behavior. Similar graph may apply to the controller.

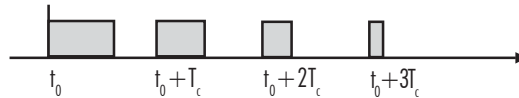

During proportional control the process controller calculates the relay activation time at certain moments  $t_0$ ,  $t_0 + T_c$ ,  $t_0 + 2T_c$  etc. The ON interval (the shaded areas) is then dependent on the error amplitude.

With the integral function (reset), the controller will reach a more stable output around the setpoint providing a more accurate control than with the ON/OFF or proportional action only.

The derivative function (rate action) compensates for rapid changes in the system reducing undershoot and overshoot of the EC or TDS value.

During PID control, the ON interval is dependent not only on the error amplitude but even on the previous measurements.

Definitely PID control provides more accurate and stable control than ON/OFF controllers and it is best suitable in system with a fast response, quickly reacting to changes due to ad-

dition of low or high conductivity solution.

An example of how the response overshoot can be improved with a proper rate action setting is depicted in the following graphic.

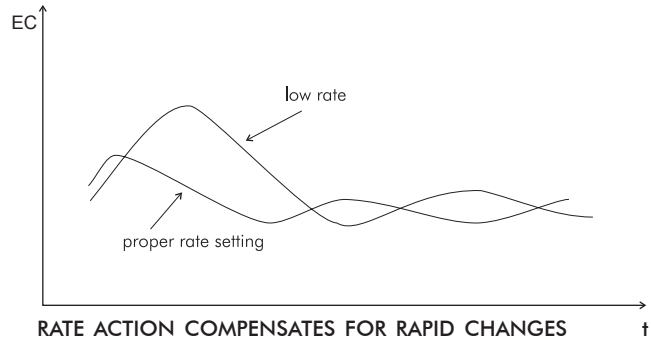

### PID TRANSFER FUNCTION

The transfer function of a PID control is as follows:

$$K_p + K_i/s + s K_d = K_p(1 + 1/(s T_i) + s T_d)$$

with  $T_i = K_p/K_i$ ,  $T_d = K_d/K_p$ ,

where the first term represents the proportional action, the second is the integrative action and the third is the derivative action.

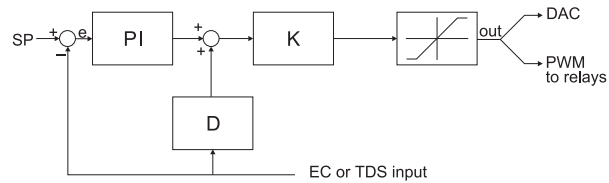

Proportional action can be set by means of the Proportional Band (PB). Proportional Band is expressed in percentage of the input range and is related to  $K_p$  according to the following:

$$K_p = 100/PB.$$

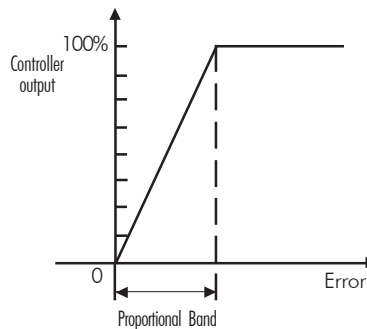

The proportional action is set through the setup procedure as “Deviation” in percent of full scale of the selected range.

Each setpoint has a selectable deviation: D1 for setpoint1 and D2 for setpoint2.

Two further parameters must be provided for both setpoints:

**Ti** =  $K_p/K_i$ , **reset time**, measured in minutes

**Td** =  $K_d/K_p$ , **rate time**, measured in minutes.

Ti1 and Td1 will be the reset time and rate time for setpoint1, while Ti2 and Td2 will be the reset time and the rate time for setpoint2.

## TUNING A PID CONTROLLER

The proportional, integrative, derivative terms must be tuned, i.e. adjusted to a particular process. Since the process variables are not typically known, a “trial and error” tuning procedure must be applied to get the best possible control for the particular process. The target is to achieve a fast response time and a small overshoot.

Many tuning procedures are available and can be applied to the EC/TDS controllers. A simple and profitable procedure is reported in this manual and can be used in almost all applications.

The user can vary five different parameters, i.e. the setpoint (S1 or S2), the deviation (D1 or D2), the reset time, the rate time and the proportional control mode period  $T_c$  (from 1 to 30 minutes).

**Note** User can disable the derivative and/or integrative action (for P or PI controllers) by setting  $T_d = 0$  and/or  $T_i = \text{MAX}(T_i)$  respectively through the setup procedure.

## SIMPLE TUNING PROCEDURE

The following procedure uses a graphical technique of analyzing a process response curve to a step input.

1. Starting from a solution with an EC or TDS value quite different from the dosed liquid, turn on the dosing device at its maximum capacity without the controller in the loop (open loop process). Note the starting time.
2. After some delay ( $T_0$ ) the EC or TDS starts to vary. After more delay, the EC or TDS will reach a maximum rate of change (slope). Note the time that this maximum slope occurs and the EC or TDS value at which it occurs. Note the maximum slope in EC or TDS per minute. Turn the system power off.
3. On the chart draw a tangent to the maximum slope point until intersection with the horizontal line corresponding to the initial EC or TDS value. Read the system time delay  $T_x$  on the time axis.

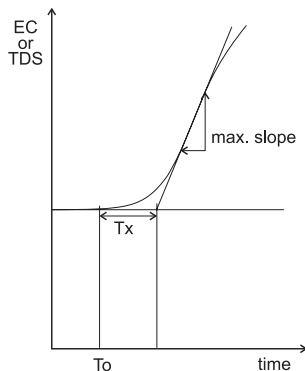

4. The deviation,  $T_i$  and  $T_d$  can be calculated from the following:
  - Deviation =  $T_x \cdot \text{max. slope (EC/TDS)}$
  - $T_i = T_x / 0.4$  (minutes)
  - $T_d = T_x \cdot 0.4$  (minutes).
5. Set the above parameters and restart the system with the controller in the loop. If the response has too much overshoot or is oscillating, then the system can be fine-tuned slightly increasing or decreasing the PID parameters one at a time.

**Note** Connecting an external device (e.g. chart recorder) to the controller, the procedure is easier and doesn't need the use of hand plotting the process variable (EC or TDS).

## ALARM RELAY

The alarm relay functions in the following manner:

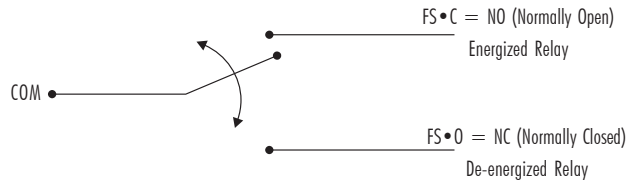

During alarm condition, the relay is de-energized. When not in alarm condition, the relay is energized.

Example: High alarm set at 1400  $\mu\text{S}$   
Low alarm set at 600  $\mu\text{S}$

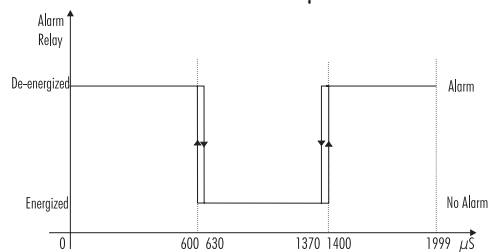

An hysteresis will eliminate the possibility of continuous sequences 'energizing/de-energizing' of the alarm relay when the measured value is close to the alarm setpoint. The alarm hysteresis amplitude is 1.5% of full scale.

Moreover the alarm signal is generated only after a user selectable time period (alarm mask) has elapsed since the controlled value has overtaken one alarm threshold. This additional feature will avoid fake or temporary alarm conditions.

**Note** If the power supply is interrupted, the relay is de-energized as if in alarm condition to alert the operator.

In addition to the user-selectable alarm relays, all EC/TDS controllers are equipped with the **Fail Safe** alarm feature.

The **Fail Safe** feature protects the process against critical errors arising from power interruptions, surges and human errors. This sophisticated yet easy-to-use system resolves these predicaments on two fronts: hardware and software. To eliminate problems of blackout and line failure, the alarm function operates in a "Normally Closed" state and hence alarm is triggered if the wires are tripped, or when the power is down.



This is an important feature since with most meters the alarm terminals close only when an abnormal situation arises, however, due to line interruption, no alarm is sounded, causing extensive damage. On the other hand, software is employed to set off the alarm in abnormal circumstances, for example, if the dosing terminals are closed for too long a period. In both cases, the red LED's will also provide a visual warning signal.

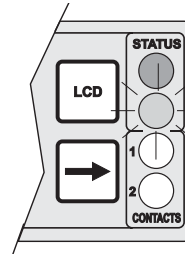

The Fail Safe mode is accomplished by connecting the external alarm circuit between the FS•C (Normally Open) and the COM terminals. This way, an alarm will warn the user when EC exceeds the alarm thresholds, during power down and in the case of a broken wire between the process meter and the external alarm circuit.

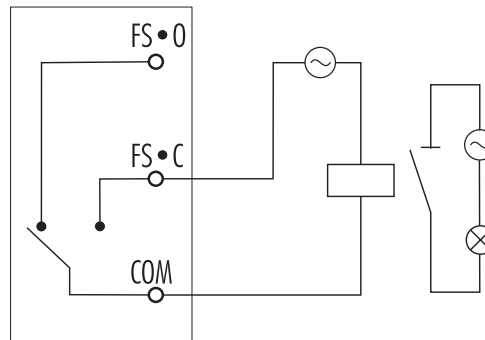

**Note** In order to have the Fail Safe feature activated, an external power supply has to be connected to the alarm device.

### CONTROL THROUGH ANALOG OUTPUT

Models HI 700, HI 705 and HI 710 have a proportional analog signal (selectable among 0-1 mA, 0-20mA, 4-20mA, 0-5VDC, 1-5VDC and 0-10VDC) at the analog output terminals. With this output, the actual output level amplitude is varied, rather than the proportion of ON and OFF times (duty cycle control). A device with analog input (e.g. a pump with a 4-20 mA input) can be connected to these terminals.

## IDLE MODE

---

Idle mode is entered through setup code 2.

During idle mode the device performs the same tasks as when it is in control mode except for the relays. The alarm relay is activated (no alarm condition), the control relays are not activated while the analog output remains activated.

When the instrument is in idle mode the red and green status LEDs are on.

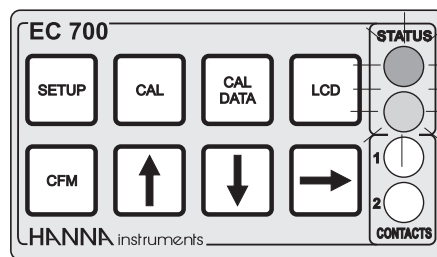

Idle mode is useful to disable control actions when the external devices are not installed or when the user detects unusual circumstances.

Control actions are stopped as soon as the user presses SETUP and enters the password.



In order to reactivate the control mode, use code 02 of setup (see "Setup" section). Otherwise, the meter remains in idle mode.

## ANALOG OUTPUT

All models are provided with the analog output feature. The output is isolated and can be a voltage or a current.

With the recorder, simply connect the common port to the ground output and the second port to the current output or voltage output (depending on which parameter is being used) as depicted aside.

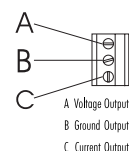

The type (voltage or current) and the range of the output analog signal is selectable through the jumpers on the power board.

Configurations of the switch are as follows:

Output	Switch 1	Switch 2	Switch 3	Switch 4
0-5 VDC, 1-5 VDC	OFF	ON	--	--
0-10 VDC	ON	OFF	--	--
0-20 mA, 4-20 mA	--	--	ON	--
0-1 mA	--	--	OFF	--

Choice between different ranges with the same configuration (for example 0-20 mA and 4-20 mA) is achieved via software by entering the setup mode and selecting code 40 (see Setup Mode section for exact procedure).

Factory default is switches 1 and 3 closed (ON) and switches 2 and 4 open (OFF), i.e. 0-20 mA, 4-20 mA and 0-10 VDC.

In any case, contact the nearest Hanna Customer Service Center for changing of the default configuration.

By default the minimum and maximum values of analog output correspond to the minimum and maximum of the selected range of the meter. For example, for the HI 700 with a selected 0 to 1999  $\mu$ S range and analog output of 4-20 mA, the default values are 0 and 1999  $\mu$ S corresponding to 4 and 20 mA, respectively.

These values can be changed by the user to have the analog

output matching a different EC or TDS range, for example, 4 mA = 30 mS and 20 mA = 50 mS.

To change the default values, the setup mode must be entered. Setup codes for changing the analog output minimum and maximum are 41 or 42, respectively. For the exact procedure, refer to the setup mode section in the manual.

**Note** The analog output is factory calibrated through software. The user may also perform the calibration procedure as explained in the following. It is recommended to perform the output calibration at least once a year.

**Note** Analog output resolution is 1.5% f.s. with 0.5% f.s. accuracy.

**Note** The analog output is “frozen” when entering the setup or calibration mode (after password confirmation).

## CALIBRATION

The controller is factory calibrated for temperature as well as for the analog input and outputs.

The user should periodically calibrate the instrument for EC or TDS. For greatest accuracy, it is recommended that the instrument is calibrated frequently.

Before beginning normal operation, it is recommended to standardize the probe with the Hanna calibration solution close to the expected sample value and inside the selected range.

### EC AND TDS CALIBRATION

The calibration points for EC and TDS are as follows:

Range	Calibration point(s)
0.0 ÷ 199.9 $\mu$ S	84.0 $\mu$ S
0 ÷ 1999 $\mu$ S	1413 $\mu$ S
0.00 ÷ 19.99 mS	5.00 - 12.88 mS
0.0 ÷ 199.9 mS	80.0 - 111.8 mS
0.0 ÷ 100.0 ppm	42.0 ppm
0 ÷ 1000 ppm	800 ppm
0.00 ÷ 10.00 ppt	6.44 ppt
0.0 ÷ 100.0 ppt	55.9 ppt

The user should select the appropriate range to calibrate (setup code 03). Calibration must be performed for each range used. The temperature probe should also be connected to the process meter. The meters are equipped with a stability indicator. The user is also guided with indications on the display during the calibration procedure.

### Initial Preparation

Pour a small quantity of the calibration solution (e.g. 1413  $\mu\text{S}$ ) into a beaker. If possible, use a plastic beaker to minimize any EMC interference.

For accurate calibration use two beakers containing the same solution, the first one for rinsing the probe, the second one for calibration. By doing this, contamination between the solutions is minimized.

To obtain accurate readings, use the calibration solution in the selected range and closer to the values to be measured.

### Offset Calibration

- To perform the EC or TDS calibration enter the calibration mode, by pressing CAL and entering the password.
- After the correct password is entered, the control actions stop and the primary LCD will display the first EC or TDS calibration value, with the "CAL" indicator blinking. The secondary LCD displays the temperature.

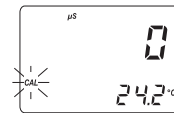

**Note** If the wrong password is entered the system reverts back to normal operation, displaying EC or TDS values.

- 0 is the default value for the 1<sup>st</sup> calibration point. Dry the conductivity probe and leave it in air.
- Only when the reading is stable the "CAL" indicator will stop flashing (after about 30 seconds) and the "READY" and "CFM" indicators will start blinking.

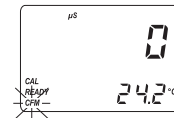

- Press CFM to confirm the calibration point; the primary LCD will display the second expected buffer value.



If the zero calibration cannot be performed, "ERROR" will blink.

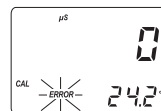

### Cell constant calibration

- Select the solution value on the primary display by pressing  $\uparrow$  or  $\downarrow$  if the selected range has two possibilities (e.g. 5.000 and 12.880 mS).



- Immerse the EC/TDS probe with the temperature sensor in the selected solution. The level of solution must be higher than the holes of the EC/TDS probe sleeve. Tap the EC/TDS probe repeatedly on the bottom of the beaker and stir to ensure that no air bubbles are trapped inside the sleeve.

- When the reading is stable, "CAL" will stop flashing (after about 30 seconds) and the "READY" and "CFM" indicators will blink.

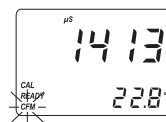

- Press CFM to confirm the calibration point; if the reading is close to the selected solution, the meter stores the reading.



If the reading is not close to the selected solution, "ERROR" will blink.

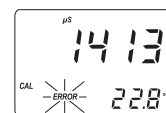

**Note** A 2-point calibration is always suggested. However the EC/TDS calibration can also be performed at 1 point. To calibrate offset only, just press CAL after confirmation (with CFM) of the zero reading; the meter will return to normal operational mode. To have the cell constant calibrated first, press the up or down arrow keys after entering the calibration procedure to skip to the next possible calibration buffer. In this case, after confirmation of the cell constant, the meter will ask for the offset calibration displaying zero on the LCD; press CAL to exit or calibrate the offset, if desired.

**Note** The EC or TDS calibration value shown is referenced at 25°C even if the reference temperature of 20°C has been selected.

**Note** During calibration, press LCD to display the cell constant value on the primary display. Press LCD again to return to calibration buffer visualization.

- Note** To interrupt the calibration procedure press SETUP to restart the procedure, or CAL to exit to normal operational mode.
- Note** If the process meter has never been calibrated or an EEPROM reset has occurred, the meter continues to perform measurements. However, the user is informed of an EC or TDS calibration requirement by a blinking "CAL" indication (see "Startup" section).
- Note** The device must be calibrated within the temperature range specified for the EC or TDS buffer solution.

### CELL CONSTANT DIRECT SELECTION

Whenever the EC/TDS probe cell constant is known, it is possible to directly calibrate the meter using that value.

- Press CAL to enter calibration mode. The LCD will show the default offset of 0.
- Press LCD to display the current cell constant on the primary LCD (factory default value is 2.000 cm<sup>-1</sup>).

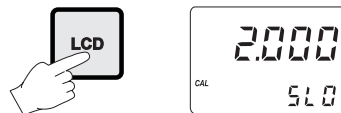

- Press SETUP key.
- Using ↑, ↓ and ⇨, enter the probe cell constant (the value must be between 1.333 and 4.000 cm<sup>-1</sup>) and confirm by pressing CFM.

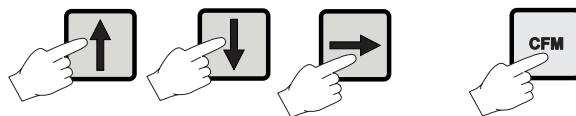

- Note** If the entered cell constant value is invalid, the "ERROR" indicator blinks on the LCD.
- Note** Press SETUP before CFM to exit without changing the cell constant.

### CALIBRATION BUFFER DIRECT SELECTION

This feature allows to set a user-defined calibration point, in order to perform calibration at a point different from the memorized standards.

- Press CAL to enter calibration mode. The LCD will show 0.

- Press SETUP key.
- Using  $\uparrow$ ,  $\downarrow$  and  $\Rightarrow$ , enter the desired buffer value and confirm by pressing CFM.

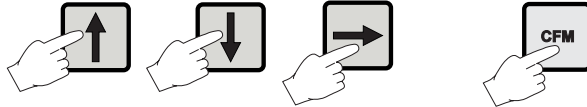

**Note** Press SETUP before CFM to exit without changes.

**Note** It is suggested to calibrate the offset before entering the calibration buffer direct selection.

## TEMPERATURE CALIBRATION

The controller is factory calibrated for temperature. However, the user may also perform a one point temperature calibration. This procedure is to calibrate the offset only; the slope will remain as factory calibrated.

- Prepare a beaker containing a solution at a given temperature inside the range of the meter.
- Use a Checktemp or a calibrated thermometer with a resolution of  $0.1^\circ$  as a reference thermometer.
- Immerse the temperature probe in the beaker as close to the Checktemp as possible.
- Press and hold first CFM and then CAL to enter the temperature calibration mode.



- Execute the password procedure.
- Select code 1 via the arrow keys for temperature calibration and confirm with CFM.
- CAL will blink on the LCD. The measured temperature will be displayed on both the primary and secondary LCD.
- Use the arrow keys to set on the secondary LCD the temperature read by the reference thermometer.
- When the reading has stabilized at a value near the calibration point, CAL will stop blinking and an intermittent CFM will prompt the user to confirm the calibration.
- If the reading stabilizes at a reading significantly variant from the first setpoint, an intermittent ERROR will prompt the user to check the beaker or bath.

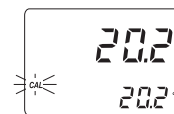



Calibration procedure may be interrupted by pressing CAL again at any time. If the calibration procedure is stopped this way, or if the controller is switched off before the last step, no calibration data is stored in non-volatile memory (EEPROM).

## ANALOG INPUT CALIBRATION

The analog input is already factory calibrated. However, the user may also perform a 2-point calibration at 4 and 20 mA. It is sufficient to perform the calibration on one range only.

- Connect a mA simulator (e.g. HI931002) to the analog input of the controller (#11 at page 7)

- Press and hold first CFM and then CAL to enter the analog input calibration mode.



- Execute the password procedure.
- Select code 0 via the arrow keys for analog input calibration and confirm with CFM. CAL will blink on the LCD.

- The secondary LCD will display "4" for the first calibration point. The primary LCD will display the conductivity reading.



- Set the mA simulator to 4 mA and wait for the reading to stabilize, CAL will stop blinking and an intermittent CFM will prompt the user to confirm the calibration.



- If the reading stabilizes at a reading significantly variant from the first calibration point, an intermittent ERROR will prompt the user to check the input.

- If everything is satisfactory the secondary LCD will display "20" for the second calibration point.



- Set the mA simulator to 20 mA and wait for the reading to stabilize, CAL will stop blinking and an intermittent CFM will prompt the user to confirm the calibration.



- Press CFM to confirm. The meter will return to normal operational mode.

Calibration procedure may be interrupted by pressing CAL again at any time. If the calibration procedure is stopped this

way, or if the controller is switched off before the last step, no calibration data is stored in non-volatile memory (EEPROM).

## ANALOG OUTPUT CALIBRATION

In the meters where the analog output is available, this feature is factory calibrated through software. The user may also perform these calibration procedures.

### IMPORTANT

It is recommended to perform the output calibration at least once a year. Calibration should only be performed after 10 minutes from power up.

- With a multimeter or an HI 931002 connect the common port to the ground output and the second port to the current output or voltage output (depending on which parameter is being calibrated).

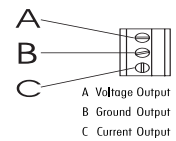

- Press and hold in sequence CFM first, then → and then CAL to enter the Analog Output Calibration mode.



- Execute the password procedure.
- The primary display will show the current selected parameter blinking. Use the ↑ to select the code (0-5 see chart below) for the desired parameter displayed on the secondary display (e.g. 4-20 mA).

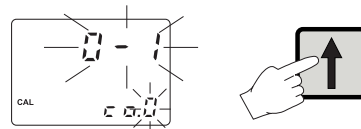

- Press CFM to confirm the selected parameter that will stop blinking on the primary display. The secondary display shows the HI 931002 or multimeter input value as lower limit of the interval.

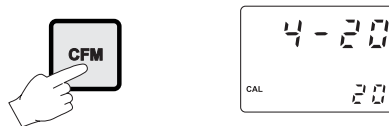

- Use the  $\uparrow$  or  $\downarrow$  to make the HI 931002 or multimeter output correspond with the meter's value shown on the secondary display (e.g. 4).

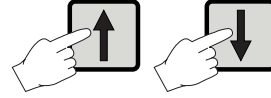

- Wait for approximately 30 seconds (until the reading of the calibrator is stable).
- Press CFM to confirm. The meter will switch to the second calibration point. Repeat the above procedure.

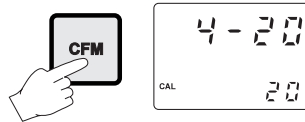

- After the desired readings are obtained, press CFM and the meter will skip back to normal operational mode.

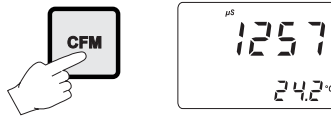

**Note** When adjusting values using the  $\uparrow$  or  $\downarrow$  keys it is important to allow for sufficient response time (up to 30 seconds)

The table below lists the values of output codes along with the calibration point values (which are the analog output minimum and the analog output maximum) as indicated on the display.

The secondary display indicates the current calibration point value, while primary display indicates the current calibration type.

OUTPUT TYPE	CALIBRATION CODE	CALIBRATION POINT 1	CALIBRATION POINT 2
0-1 mA	0	0 mA	1 mA
0-20 mA	1	0 mA	20 mA
4-20 mA	2	4 mA	20 mA
0-5 VDC	3	0 VDC	5 VDC
1-5 VDC	4	1 VDC	5 VDC
0-10 VDC	5	0 VDC	10 VDC

## LAST CALIBRATION DATA

The meter can display the following last calibration data:

- Date
- Time
- Cell constant

While displaying these data, the controller remains in control mode. The data are related to the selected range only.

The procedure below indicates the flow. Displaying of the items follows the above sequence.

- To begin the cycle press CAL DATA. The last calibration date will appear on the primary LCD as DD.MM format, while the secondary display will show the year.



If the meter has never been calibrated or an EEPROM reset has occurred, no calibration data are shown when CAL DATA is pressed. The "no CAL" message will blink for a few seconds, then the meter skips back to normal mode.



- Press  $\uparrow$  or  $\downarrow$  to cycle through the data forward or backwards respectively.



**Note** In any moment, by pressing LCD or CAL DATA the meter will return to the regular operating display.

- Press  $\uparrow$  or  $\Rightarrow$  to view the time of last calibration. The secondary display will show "HOU".

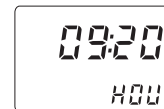

- Press  $\uparrow$  or  $\Rightarrow$  again to view the cell constant at the time of last calibration. The secondary display will show "CEL".

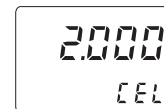

- Press  $\uparrow$  or  $\Rightarrow$  again to return to the first CAL DATA display (date) at the time of last calibration.

## FAULT CONDITIONS AND SELFTEST PROCEDURES

The fault conditions below may be detected by the software:

- EEPROM data error;
- I2C internal bus failure;
- date lost;
- code dead loop.

EEPROM data error can be detected through EEPROM test procedure at startup or when explicitly requested using setup menu.

When an EEPROM error is detected, user is given the option to perform a reset of EEPROM.

**Note** When an EEPROM reset has been performed calibration data are reset to default (every range). An intermittent CAL will blink on the display to advise the user of this status.



A I2C failure is detected when the I2C transmission is not acknowledged or a bus fault occurs for more than a certain number of attempts (this can be due, for example, to damage sustained by one of the ICs connected to I2C bus).

If so, the controller stops any tasks and displays a perpetual sliding message “Serial bus error” (i.e. this is a fatal error).



If an invalid date is read from RTC, it is initialized back to the default date and time (01/01/98 - 00:00).

The error detection for dead loops is performed by watchdog (see below).

You can use special setup codes, perform selftest procedures for LCD, keyboard, EEPROM, relays and LEDs, watchdog. The operation of these functions is outlined in the setup section. The selftest procedures are described in detail in the following subsections.

### DISPLAY SELFTEST

The display selftest procedure consists of lighting up all of the display segments together. The Display test is announced by a

scrolling "Display test" message.



The segments are lit for a few seconds and then switched off before exiting the selftest procedure.

### KEYBOARD SELFTEST

The keyboard selftest procedure begins with the message "Button test, press LCD, CAL and SETUP together to escape". The LCD will then show only a colon.



As soon as one or more keys are pressed, the appropriate segments out of *BB:BB* corresponding to the pressed keys, will light up on the screen.

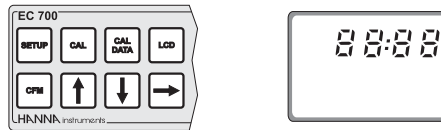

For example, if CFM and CAL DATA are pressed together the LCD will look like this:

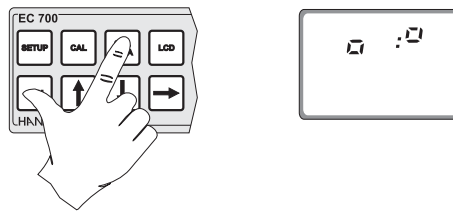

The colon is a useful indicator for the correct position of squares.

**Note** A maximum of two keys may be pressed simultaneously to be properly recognized.

To exit the keyboard test procedure press LCD, CAL and SETUP simultaneously.



## EEPROM SELFTEST

The EEPROM selftest procedure involves verifying the stored EEPROM checksum. If the checksum is correct the "Stored data good" message will be shown for a few seconds before exiting selftest procedure.



Stored data Good

If not, the message "Stored data error - Press  $\hat{u}$  to reset stored data or  $\Rightarrow$  to ignore".

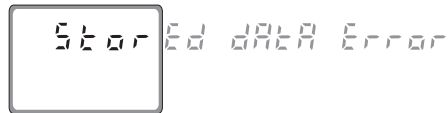

Stored data Error

If  $\Rightarrow$  is pressed the EEPROM selftest procedure terminates with no other action. Otherwise, EEPROM is reset with default values from ROM as when a device with a virgin EEPROM is switched on.

During EEPROM reset a blinking message "Set" is shown on primary LCD; the secondary LCD displays "MEM".



SET

At the end of this operation all the parameters are reset to their default values. The calibrated cell constant is also reset. For this reason the "CAL" flag blinks until the EC/TDS calibration is performed.



MEM  
1354  
22.7°C

## RELAYS AND LEDS

Relays and LEDs selftests are executed as follows:

First all of the relays and LEDs are switched off, then they are switched on one at a time for a few seconds and cyclically. User can interrupt the otherwise endless cycle pressing any key, as indicated by the scrolling message.



PRESS ANY button to ESCAPE

**Note** Relays and LEDs test has to be carried out with the relay contacts disconnected from external plant devices.

## WATCHDOG

When a dead loop condition is detected a reset is automatically invoked.

The effectiveness of watchdog capability can be tested through one of the special setup items. This test consists of executing a dummy dead loop that causes watchdog reset signal to be generated.

## EXTERNAL FUNCTIONS

---

### HOLD FUNCTION

This function allows to perform the maintenance procedures. When the relevant digital insulated input (terminals #6 on page 7) is on, the analog output is frozen at its last value and control and alarm relays are disabled. The “Hld” indication is displayed on the secondary LCD when the function is active. A 5 to 24 VDC voltage can be applied to this input.



While in hold state, it is possible to display the temperature reading on the secondary LCD pressing the right arrow key. Only when the key is released, the secondary LCD returns automatically after a few seconds to the “Hld” indication.



### PRESETTABLE TIMER (CLEANING FUNCTION)

A timer is presettable by software to open a digital insulated contact (terminals #5 on page 7) after a user programmable time interval with a minimum interval of 1 day (e.g. for probe cleaning function). The time interval is programmable in number of days through setup code 72.



This output is ON for the period set through setup code 77 (this period can be also changed when the output is ON).

The starting time of the cleaning timer can be set through setup codes 73, 74, 75 and 76.



## STARTUP

---

During the automatic startup the Real Time Clock (RTC) is checked to see if a reset occurred since last software initialization. In this case, the RTC is initialized with the default date and time 01/01/1998 - 00:00. An EEPROM reset does not affect the RTC settings.

The EEPROM is also checked to see if it is new. If this is the case, the default values are copied from ROM and then the device enters normal mode. Otherwise an EEPROM checksum test is performed (the same is performed during EEPROM selftest procedure).

If checksum is correct, normal mode is entered, otherwise the user is asked whether the EEPROM should be reset.

If EEPROM reset is requested, default values from ROM are stored into EEPROM as would happen with a new EEPROM.

Note that EEPROM data is composed of setup data and calibration data. As for the setup data, the calibration data is assigned default values when an EEPROM reset occurs. An un-calibrated meter can perform measurement, though user is informed that EC or TDS calibration is needed by means of a blinking "CAL".

When the last calibration data is required, the "no CAL" message is displayed if no calibration procedure was performed.



Unlike EC/TDS calibration, the user has no information on calibration need for other ranges, other than the awareness that EEPROM was reset.

After an EEPROM reset, all calibrations (input and output) have to be performed in order to obtain correct measurements.

## EC VALUES AT VARIOUS TEMPERATURES

Temperature has a significant effect on conductivity. Table below shows EC values at various temperatures for the Hanna calibration solutions.

TEMPERATURE		EC VALUES ( $\mu\text{S}/\text{cm}$ )					
°C	°F	HI7030 HI8030	HI7031 HI8031	HI7033 HI8033	HI7034 HI8034	HI7035 HI8035	HI7039 HI8039
0	32	7150	776	64	48300	65400	2760
5	41	8220	896	65	53500	74100	3180
10	50	9330	1020	67	59600	83200	3615
15	59	10480	1147	68	65400	92500	4063
16	60.8	10720	1173	70	67200	94400	4155
17	62.6	10950	1199	71	68500	96300	4245
18	64.4	11190	1225	73	69800	98200	4337
19	66.2	11430	1251	74	71300	100200	4429
20	68	11670	1278	76	72400	102100	4523
21	69.8	11910	1305	78	74000	104000	4617
22	71.6	12150	1332	79	75200	105900	4711
23	73.4	12390	1359	81	76500	107900	4805
24	75.2	12640	1386	82	78300	109800	4902
25	77	12880	1413	84	80000	111800	5000
26	78.8	13130	1440	86	81300	113800	5096
27	80.6	13370	1467	87	83000	115700	5190
28	82.4	13620	1494	89	84900	117700	5286
29	84.2	13870	1521	90	86300	119700	5383
30	86	14120	1548	92	88200	121800	5479
31	87.8	14370	1575	94	90000	123900	5575

## **EC / TDS PROBE MAINTENANCE**

---

Probe can be compensated for normal contamination by a process of recalibration. When calibration can no longer be achieved, remove the conductivity probe from the system for maintenance.

### **PERIODIC MAINTENANCE**

Inspect the probe and the cable. The cable used for the connection to the controller must be intact and there must be no points of broken insulation on the cable.

Connectors must be perfectly clean and dry.

### **CLEANING PROCEDURE**

Rinse the probe with tap water. If a more thorough cleaning is desired, remove the sleeve and clean the platinum sensors with a non-abrasive cloth or HI7061 cleaning solution. Reinsert the sleeve in the same direction as before.

Recalibrate the instrument before reinserting the probe in the system.

**Note** Always recalibrate the instrument when attaching a new probe.

## ACCESSORIES

---

### CONDUCTIVITY & TDS BUFFER SOLUTIONS

HI 7030L	12880 $\mu\text{S}/\text{cm}$ ( $\mu\text{mho}/\text{cm}$ ), 460mL
HI 7030M	12880 $\mu\text{S}/\text{cm}$ ( $\mu\text{mho}/\text{cm}$ ), 230mL
HI 7031L	1413 $\mu\text{S}/\text{cm}$ ( $\mu\text{mho}/\text{cm}$ ), 460mL
HI 7031M	1413 $\mu\text{S}/\text{cm}$ ( $\mu\text{mho}/\text{cm}$ ), 230mL
HI 7033L	84 $\mu\text{S}/\text{cm}$ ( $\mu\text{mho}/\text{cm}$ ), 460 mL
HI 7033M	84 $\mu\text{S}/\text{cm}$ ( $\mu\text{mho}/\text{cm}$ ), 230 mL
HI 7034L	80000 $\mu\text{S}/\text{cm}$ ( $\mu\text{mho}/\text{cm}$ ), 460mL
HI 7034M	80000 $\mu\text{S}/\text{cm}$ ( $\mu\text{mho}/\text{cm}$ ), 230mL
HI 7035L	111800 $\mu\text{S}/\text{cm}$ ( $\mu\text{mho}/\text{cm}$ ), 460mL
HI 7035M	111800 $\mu\text{S}/\text{cm}$ ( $\mu\text{mho}/\text{cm}$ ), 230mL
HI 7039L	5000 $\mu\text{S}/\text{cm}$ ( $\mu\text{mho}/\text{cm}$ ), 460mL
HI 7039M	5000 $\mu\text{S}/\text{cm}$ ( $\mu\text{mho}/\text{cm}$ ), 230mL
HI 7032L	1382 ppm (mg/L), 460 mL
HI 7032M	1382 ppm (mg/L), , 230 mL
HI 7036L	12.41 ppt (g/L), 460 mL
HI 7036M	12.41 ppt (g/L), 230 mL
HI 70038P	6.44 ppt (g/L), 25 mL sachets, 25 pcs.
HI 70080P	800 ppm (mg/L), 25 mL sachets, 25 pcs.
HI 7042	42 ppm (mg/L), 1 L
HI 7038	6.44 ppt (g/L), 1 L
HI 7037	800 ppm (mg/L), 1 L
HI 7055	55.9 ppt (g/L), 1 L

### CONDUCTIVITY BUFFER SOLUTIONS IN FDA APPROVED BOTTLES

HI 8030L	12880 $\mu\text{S}/\text{cm}$ ( $\mu\text{mho}/\text{cm}$ ), 460 mL
HI 8031L	1413 $\mu\text{S}/\text{cm}$ ( $\mu\text{mho}/\text{cm}$ ), 460 mL
HI 8033L	84 $\mu\text{S}/\text{cm}$ ( $\mu\text{mho}/\text{cm}$ ), 460 mL
HI 8034L	80000 $\mu\text{S}/\text{cm}$ ( $\mu\text{mho}/\text{cm}$ ), 460 mL
HI 8035L	111800 $\mu\text{S}/\text{cm}$ ( $\mu\text{mho}/\text{cm}$ ), 460 mL
HI 8039L	5000 $\mu\text{S}/\text{cm}$ ( $\mu\text{mho}/\text{cm}$ ), 460 mL

### **ELECTRODE CLEANING SOLUTIONS**

HI 7061M                    General Cleaning Sol., 230 mL  
HI 7061L                    General Cleaning Sol., 460 mL

### **ELECTRODE CLEANING SOLUTIONS IN FDA APPROVED BOTTLES**

HI 8061M                    General Cleaning Sol., 230 mL  
HI 8061L                    General Cleaning Sol., 460 mL

### **OTHER ACCESSORIES**

HI 7639                    4-ring EC/TDS probe with built-in 3-wire PT100 temperature sensor and 5 mt shielded cable

BL PUMPS                    Dosing Pumps with Flow Rate from 1.5 to 20 LPH

ChecktempC                Stick Thermometer (range -50.0 to 150.0°C)

HI 8936A                    EC Transmitter 0.0-199.9 mS/cm

HI 8936B                    EC Transmitter 0.00-19.99 mS/cm

HI 8936C                    EC Transmitter 0-1999 µS/cm

HI 8936D                    EC Transmitter 0.0-199.9 µS/cm

HI 98143 series (4-20mA) EC Isolated Transmitter 0-10 mS/cm

HI 98144 series (4-20mA) EC Isolated Transmitter 0-4 mS/cm

HI 931002                    4-20 mA Simulator

## WARRANTY

---

All Hanna Instruments **meters are guaranteed for two years** against defects in workmanship and materials when used for their intended purpose and maintained according to instructions. **The probes are guaranteed for a period of six months.** This warranty is limited to repair or replacement free of charge.

Damage due to accident, misuse, tampering or lack of prescribed maintenance are not covered.

If service is required, contact the dealer from whom you purchased the instrument. If under warranty, report the model number, date of purchase, serial number and the nature of the failure. If the repair is not covered by the warranty, you will be notified of the charges incurred. If the instrument is to be returned to Hanna Instruments, first obtain a Returned Goods Authorization number from the Customer Service department and then send it with shipping costs prepaid. When shipping any instrument, make sure it is properly packaged for complete protection.

Hanna Instruments reserves the right to modify the design, construction and appearance of its products without advance notice.

# CE DECLARATION OF CONFORMITY

										
<b>CE</b> <i>DECLARATION OF CONFORMITY</i>										
We Hanna Instruments Italia Srl Via E.Fermi, 10 35030 Sarmeola di Rubano - PD ITALY										
herewith certify that the microprocessor-based process controllers <b>EC 700 TDS 705 EC 710</b>										
have been tested and found to be in compliance with the following regulations:										
<table><tr><td>IEC 801-2</td><td>Electrostatic Discharge</td></tr><tr><td>IEC 801-3</td><td>RF Radiated</td></tr><tr><td>IEC 801-4</td><td>Fast Transient</td></tr><tr><td>EN 55022</td><td>Radiated, Class B</td></tr><tr><td>EN 61010-1</td><td>Electrical Safety</td></tr></table>	IEC 801-2	Electrostatic Discharge	IEC 801-3	RF Radiated	IEC 801-4	Fast Transient	EN 55022	Radiated, Class B	EN 61010-1	Electrical Safety
IEC 801-2	Electrostatic Discharge									
IEC 801-3	RF Radiated									
IEC 801-4	Fast Transient									
EN 55022	Radiated, Class B									
EN 61010-1	Electrical Safety									
Date of Issue: <u>25-1-1999</u>	 D. Volpato - Engineering Manager On behalf of Hanna Instruments S.r.l.									

## Recommendations for Users

Before using these products, make sure that they are entirely suitable for the environment in which they are used.

Operation of these instruments in residential areas could cause unacceptable interferences to radio and TV equipment.

To maintain the EMC performance of equipment, the recommended cables noted in the user's manual must be used.

Any variation introduced by the user to the supplied equipment may degrade the instruments' EMC performance.

To avoid electrical shock, do not use these instruments when voltage at the measurement surface exceed 24VAC or 60VDC.

To avoid damage or burns, do not perform any measurement in microwave ovens.

Unplug the instruments from power supply before the replacement of the fuse.

External cables to be connected to the rear panel should be terminated with cable lugs.

PRINTED IN  
PORTUGAL

MANEC700R1  
04/99



---

<http://www.hannacn.com>